



Cloud Connected Time & Attendance System

Product Manual

BN6000/BN6100/BN6500/BN6600

CONTENTS



01

INTRODUCTION

3



02

YOUR uATTEND ACCOUNT

4



03

DEPARTMENTS

8



04

EMPLOYEES

10



05

TIME CLOCK ACTIVATION

12



06

WALL MOUNT

15



07

FINGERPRINT TEMPLATES

17



08

KEYPAD

22



09

MENUS

24



10

TROUBLESHOOTING

28



11

TEMPLATE ASSIGNMENT SHEET

30



12

CHARACTER TABLES

32



13

LIMITED WARRANTY

36



14

SAFETY INFORMATION

39



01 INTRODUCTION

Setting up your uAttend Time Clock requires an interaction between your Time Clock and Cloud Portal.

First we'll begin in the Cloud, then we'll finish with the Time Clock.

Once you've completed the following 5 easy steps, your employees will be ready to use the time clock.



CREATE YOUR
ACCOUNT



ADD DEPARTMENTS
AND EMPLOYEES



ACTIVATE YOUR
TIME CLOCK



HANG YOUR
TIME CLOCK



ADD
FINGERPRINTS



02

CREATE YOUR uATTEND ACCOUNT

- ▲ Before you can set up your new uAttend Time Clock, you will need to set up your uAttend Cloud Account.

Creating your uAttend Account
Open your web browser and visit
www.TrackMyTime.com/signup
then follow the prompts.



QUESTIONS? Call 800-518-8925 or Email support@trackmytime.com

Here are some helpful tips to make the setup as smooth as possible.

Your Dealer ID will be found on the back of your Quick Start Guide.

If the Dealer ID is missing, please contact Customer Support.

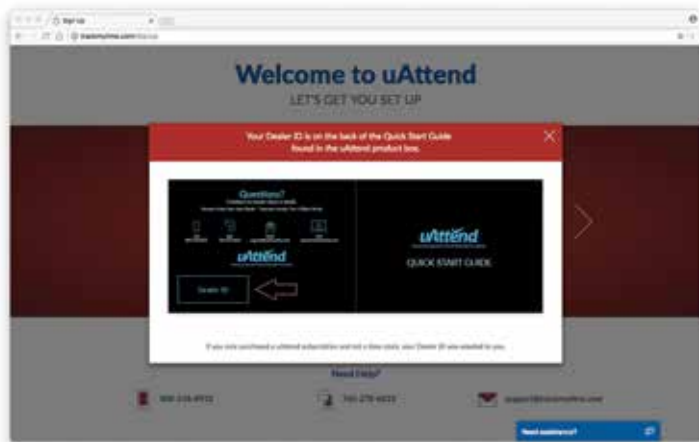

When selecting your plan size, keep in mind that your **employees** are your hourly workforce.

Supervisors (not paid hourly) and administrators are not included in this number. Your plan is month-to-month and can be changed at any time.

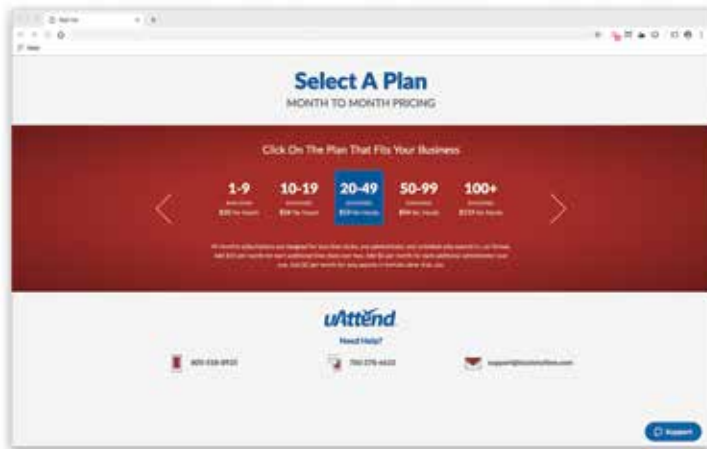

Your login URL is going to become the “web address” for your company’s uAttend Portal. For example, “The Great Cookie Co” may become **trackmytime.com/gr8cookieco**

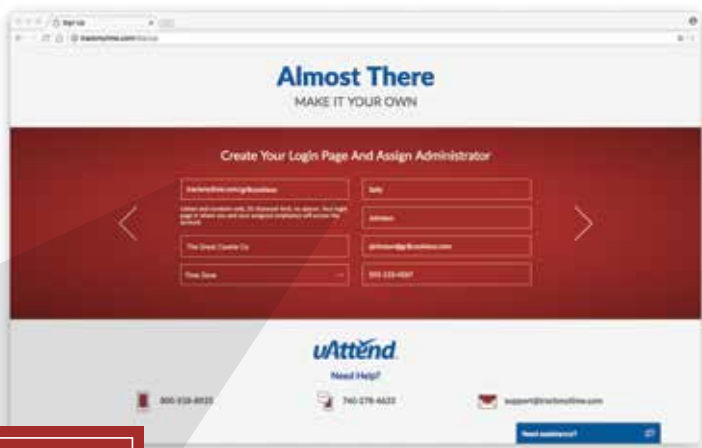

trackmytime.com/gr8cookieco



03 ADD DEPARTMENTS

Departments are used to group users together within the uAttend system. You will need to set up at least one department before you add users to your account. Specify other department settings, such as Punch Rounding and Overtime Rules, during the initial setup or you may choose to enter that information later.

1. Select the Departments tab on your Dashboard.

2. Select “+Add Department.”

3. Create a Department Code.

The Department Code is used as a reference on employee time cards to ensure that hours are appropriately allocated to the correct departments. For example, the code for “Sales” can be, “SLS.”

The screenshot shows the 'Add Department' form with the following fields and values:

General	
Code	SLS
Department Name	Enter Name
Punch Rounding	OFF
Employees punch for breaks?	NO
Paid break/duration	OFF
Employees punch for Lunch?	NO
Lunch deduction/duration	OFF

Overtime	
Weekly/BI-weekly Overtime	OFF

Advanced

4. Enter the full Department Name.

Specify additional department settings on this screen now, or enter that information later.

5. Select...

- “Save & Add New” to add a new department.
- “Save & Continue” to add more rules and policies.
- “Save & Close” to move to the next step.

The screenshot shows a web-based form for configuring department settings. The form is organized into sections with horizontal dividers. The 'Basic' section includes five settings: 'Punch Rounding' (OFF), 'Employees punch for break?' (NO), 'Paid break/duration' (OFF), 'Employees punch for Lunch?' (NO), and 'Lunch deduction/duration' (OFF). The 'Overtime' section includes 'Weekly/91-weekly Overtime' (OFF). The 'Advanced' section includes 'Day Changes At' (12:00 AM), 'Maximum Shift' (14), 'New Shift Starts' (3), and 'Night Shift' (NO). At the bottom of the form, there are three buttons: 'CANCEL', 'SAVE & ADD NEW', 'SAVE & CONTINUE', and 'SAVE & CLOSE'. The interface has a dark grey sidebar on the left and right.

Punch Rounding	OFF
Employees punch for break?	NO
Paid break/duration	OFF
Employees punch for Lunch?	NO
Lunch deduction/duration	OFF

Overtime

Weekly/91-weekly Overtime	OFF
---------------------------	-----

Advanced

Day Changes At	12:00 AM
Maximum Shift	14
New Shift Starts	3
Night Shift	NO

CANCEL SAVE & ADD NEW SAVE & CONTINUE SAVE & CLOSE



04

ADD EMPLOYEES

The number of employees you can add to your account is limited by the plan size you have chosen.

Optionally change the size of your plan at any time by selecting your user icon in the upper right corner of your uAttend Portal, then **“My Account”** from the dropdown menu.

1. Select the Users tab on your Dashboard.

2. Select “Add User.”

Add User

General

Role	Employee
First Name	Enter first name
Last Name	Enter last name
Department	0000000
Department Transfer	Off
Exemption Status	Non-Exempt
Timezone	Select Timezone
User name	Enter user name
Password	Enter password
Email	Enter email
Phone	Enter phone

3. Assign the user a role, then add their first and last name.

Employees are the portion of your workforce that use the time clock to track their time.

Supervisors can view and edit time cards, but do not punch in and out of the time clock.

Administrators have full access to the account and its settings. Additional administrators can be added for \$6 per month, per administrator.

4. Select...

- a. **“Save and Continue”** to set up the employee’s profile.
- b. **“Save and Close”** to move on to the next steps.

You can add more details by going back to that user’s profile at any time.



05

ACTIVATE YOUR TIME CLOCK

The BN6000 and BN6100 allow you to connect to the Internet via LAN, while the BN6500 and BN6600 allow you to connect via LAN and WiFi. The process of activating your time clock via LAN is the same for the BN6000, BN6100, BN6500 and BN6600, so they have been grouped together in this step.

ACTIVATION VIA LAN

1. Attach a LAN cable to your clock and router, then plug your clock into a power outlet.

Your clock should be powered on. Select LAN (option 2) on your BN6500 and BN6600.

2. Enter your uAttend Company ID.

This ID can be found in the upper right corner of your uAttend Web Portal. If you do not have an account, please set one up, as outlined in step 2.

1234567890

Press **OK** to Enter

Don't have an account?

Create an account at
trackmytime.com/signup

3. Confirm that your account information is correct.
4. Select a time zone based on the location of the clock.
5. Press OK when setup is complete.

ACTIVATION VIA WIFI

1. Plug your time clock into a power outlet.
Your clock should be powered on.
2. Select 1 for WiFi.
3. Press OK to view a list of WiFi Networks.
4. Select and confirm your Network.
5. Enter your password.

See the character table in the back of the manual for assistance.

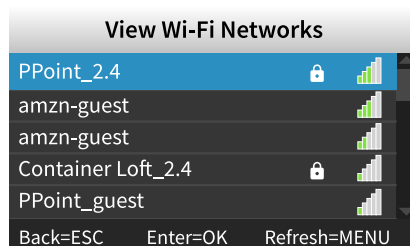
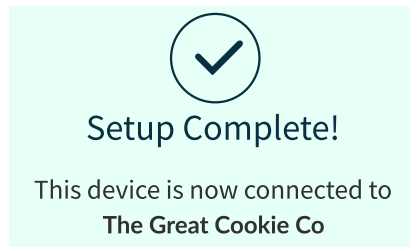

6. Confirm that your password is correct.

7. Enter your Company ID and press OK.

Your Company ID can be found in the upper right corner of your uAttend Web Portal. If you do not have an account, please set one up as outlined in step 2.

8. Confirm that your account information is correct.

9. Select a time zone based on the location of the clock.

10. Press OK when setup is complete.

WIFI Password Set Back=ESC Enter=OK

Please Input Password

[English]

1234567890

Press **OK** to Enter

Don't have an account?
Create an account at
trackmytime.com/signup

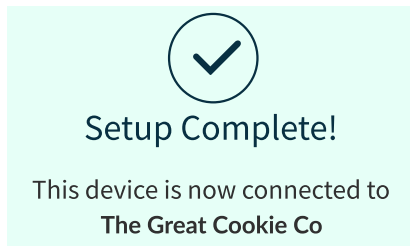



06

WALL MOUNT

Included with your time clock, you will find a metal back plate, a LAN cord, a power adapter, four drywall anchors, four screws, and a small bracket screw. You will need your own Phillips-head screwdriver.

MOUNTING YOUR TIME CLOCK ONTO YOUR WALL

1. Select a location for your time clock near a power outlet and LAN port (if applicable).
2. Place the metal back plate against the wall (shown at right). Mark the holes against the wall.
3. Insert drywall anchors into the center of the wall marks.
4. Align the metal back plate with the holes. Ensure that the prongs are facing away from the wall and upward, then secure the back plate to the wall with the included screw.

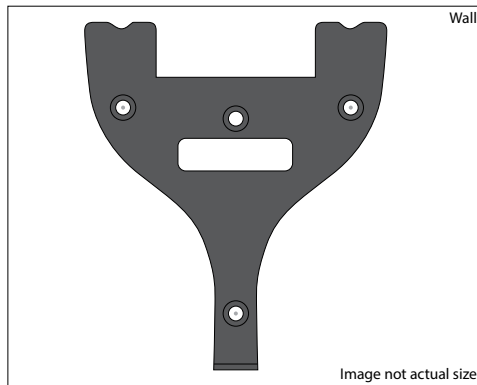

5. Attach the power adapter and the LAN line (if applicable).

6. Align the three slots on the back of the clock with the three prongs on the back plate. Push down slightly to ensure the clock is securely fastened.

7. Optionally screw the time clock to the metal back plate with the included bracket screw at the bottom center of the time clock.

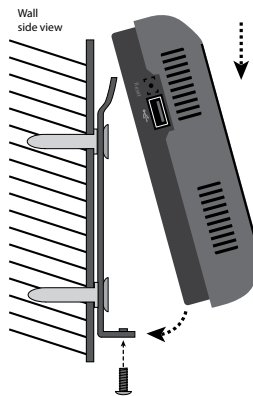
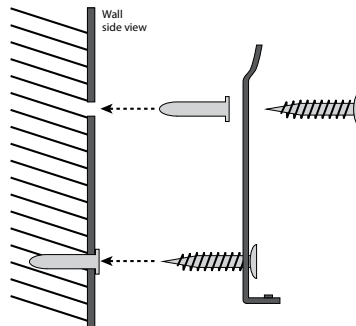

07

FINGERPRINT TEMPLATES

uAttend's unique biometric fingerprint time clock allows you to register employee fingerprints and transfer them between uAttend BN Series Time Clocks.

REGISTERING FINGERPRINT TEMPLATES

1. Press the **MENU** key.
2. Enter the default password (53178). Press **OK**.
3. Select **User Management**.
4. Select **Add User**.
5. Enter a 6 digit FP ID code for the fingerprint template and press **OK**. Each template must be assigned a unique code, we recommend using a number that is easy to remember such as a birth date. For example, June 16, 1984 could be 061684.

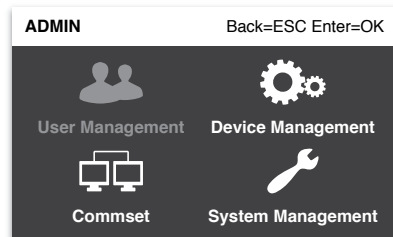
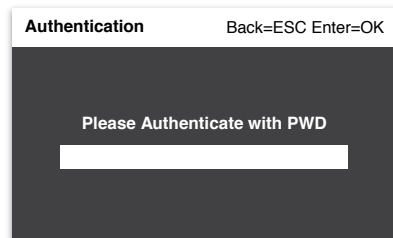

6. The employee should press their finger firmly on sensor until a “beep” is audible. Repeat process two more times with the same finger.

NOTE: If desired, you may repeat the fingerprint scanning process for the same employee with a different finger, so that the employee can have a backup template. You will need a unique 6 digit FP ID code for each fingerprint registered.

You may log all employee names and 6 digit FP ID codes in the Template Assignment Sheet at the end of this manual.

7. Repeat steps 1-6 for each employee using your time clock.

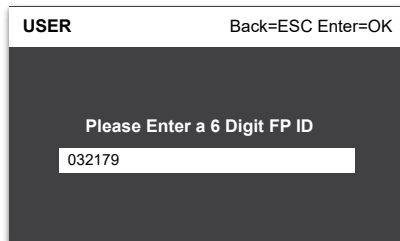
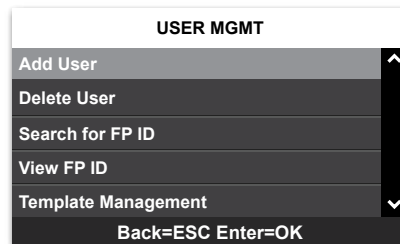

ASSIGNING FINGERPRINT TEMPLATES IN YOUR uATTEND ACCOUNT

1. Select the **Settings Tab** on the Main Menu.

2. Select the **Punch Management** link.

3. Select the **Assign Users** link that appears next to the clock name used to register fingerprint templates.

4. Assign each fingerprint template to the appropriate employee, referencing the Template Assignment Sheet at the end of this manual.

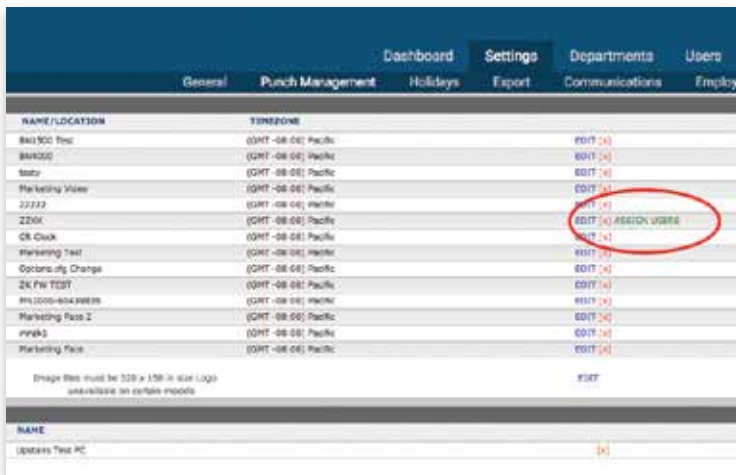

NAME/LOCATION	TIMEZONE	
BN1500 Pac	(GMT -08:00) Pacific	EDIT [X]
BN1550	(GMT -08:00) Pacific	EDIT [X]
BN1570	(GMT -08:00) Pacific	EDIT [X]
Marketing View	(GMT -08:00) Pacific	EDIT [X]
ZZ06	(GMT -08:00) Pacific	EDIT [X] ASSIGN USERS
CR Clock	(GMT -08:00) Pacific	EDIT [X]
Marketing Test	(GMT -08:00) Pacific	EDIT [X]
Options only Change	(GMT -08:00) Pacific	EDIT [X]
ZK PW TEST	(GMT -08:00) Pacific	EDIT [X]
BN1500-6049888	(GMT -08:00) Pacific	EDIT [X]
Marketing Face 2	(GMT -08:00) Pacific	EDIT [X]
INPEAS	(GMT -08:00) Pacific	EDIT [X]
Marketing Face	(GMT -08:00) Pacific	EDIT [X]
Image Res. must be 320 x 150 in 604 Logo available on certain reports		EDIT
NAME		
GEN455 Test PC		[X]

Your time clock is now ready for registered employees to punch in and out with their fingerprints.

NOTE: The BN Series employs advanced fingerprint technology. However, there is a small segment of the population with fingerprints that will not record. These employees are still able to punch in and out using a PIN.

TRANSFERRING FINGERPRINT TEMPLATES TO OTHER TIME CLOCKS

This process requires an interaction with your BN Series Time Clock and your uAttend Cloud Account.

From your uAttend account:

1. Select the **Users** tab on the Main Menu.
2. Select **Manage Fingerprint Templates**.
3. Check the desired fingerprint templates to transfer to an additional clock.
4. Use the dropdown menu to select the clock(s) to which you wish to transfer the templates.
5. Select **Submit**.



Follow these steps on each clock you wish to receive the templates:

1. Press the **MENU** key.
2. Enter your password (default is 53178). Press **OK**.
3. Select the **User Management** icon. Press **OK**.
4. Select **Template Management** using the down arrow key. Press **OK**.
5. Select **Download Templates** using the down arrow key. Press **OK**.
6. After the templates download to the clock, press **OK** at the **Success Screen**.

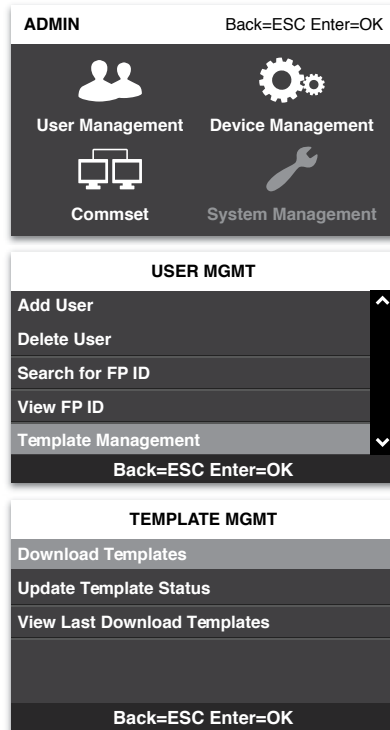



08 USING YOUR KEYPAD

The table below explains the functionality of each key on the keypad.

KEY	FUNCTION
1-0	Digits function as numbers for performing functions such as entering a PIN.
MENU	<p>Pressing the MENU key prompts a login screen for three levels of time clock access: Administrator, Super User, and Template Manager.</p> <p>Administrator: The default password is 53178. Administrators can access Admin menu to perform all available functions.</p> <p>Super User: The default password is 6318. Super Users can access User Management, Templates, and System Management.</p> <p>Template Manager: The default password is 1789. Template managers can access the time clock user templates.</p> <p>The administrator has the power to change all default passwords.</p> <p>Use the Super User and Template Manager roles to allow supervisors to assist you with templates.</p>

ESC/B-L	Pressing the ESC/B-L key in standby mode enables selecting the Break Punch or Lunch Punch function. In all other modes, this key is used to exit from a menu or cancel a function.
DT-JT/UP ARROW	Pressing the DT-JT/Up Arrow key in standby mode enables selecting the Department Transfer or Job Tracking function. In all other modes, this key is used to scroll up.
PIN/DOWN ARROW	Pressing the PIN/Down Arrow key in standby mode allows user to enter their PIN. In all other modes, this key is used to scroll down.
OK	Used to accept key entries.
	Used to access the uAttend menu (time card and employee service options).

NOTE: To make changes to a menu option, press the MENU key, use the up and down keys to make your selection, then press OK.



09

USING YOUR MENUS

The BN6000, BN6100, BN6500, and BN6600 allow 3 levels of time clock access: Administrator, Super User, and Template Manager. Each user type can access specific menus to perform necessary functions.

Administrator Menus

The **User Management** menu offers the following options:

- **Add User**—used to register user templates on your time clock.
- **Delete User**—used to delete user templates on your time clock.
- **Search for FP ID**—used to search for user information by entering a fingerprint ID.
- **View FP ID**— used to identify which templates belong to a user. A user will press their finger on the sensor and the time clock will display the fingerprint ID currently assigned to that user.
- **Template Management**—allows you to download templates, update template status, or view last downloaded templates.
- **Change Password**— used to change the default passwords for the Administrator, Super User, and Template Manager.

The **Device Management** menu offers the following options:

- **Update Time**—used to synchronize a new time, if time settings in your uAttend account change.
- **Device ID**—used to display your Device ID.
- **Download Logo**—used to import a logo from your uAttend Account to display on your time clock.
- **Time Date**—used to change the date and time display on your time clock.
- **Sound**—used to turn your time clock sounds on and off.
- **Change Currency Icon**—used to change the currency icon on display.

The **CommSet** menu offers the following options:

All models:

- **LAN Settings**—displays the DHCP status, current IP address, Subnet Mask, Gateway, DNS addresses, and Netspeed settings for LAN.
- **Proxy Server Settings**—used to enable proxy server communication and to enter proxy server settings.

BN6500 and BN6600 models only:

- **WiFi Settings**—displays the DHCP status, current IP address, Subnet Mask, Gateway, and DNS addresses for WiFi.

- **Delete Network Settings**—allows you to delete your time clock's network settings.
- **View WiFi Networks**—displays networks to which you can connect your time clock.
- **Communicating Interface**—allows you to select LAN or WiFi interface. If this option is set to LAN, the WiFi Settings and View WiFi Networks options will not display. If this option is set to WiFi, the LAN Settings option will not display.

The **System Management** menu offers the following options:

- **Reset to Factory Settings**—resets your time clock to the factory default settings.
- **Help**—displays the Customer Support telephone number and allows you to issue a support ticket.
- **Diagnostics**—used to test fingerprint sensor, RTC, and audio.
- **MAC Address**—displays your time clock's MAC address.
- **Update Firmware**—updates your time clock's firmware to the most current version.
- **Display Firmware Version**—displays your time clock's current firmware version.

Super User Menus

The **User Management** menu offers the following options:

- **Add User**—used to register user templates on your time clock.

- **Template Management**—allows you to download templates, update a template status, or view last downloaded templates.

The **System Management** menu offers the following option:

- **Help**—displays the Customer Support telephone number and allows user to issue a support ticket.

Template Manager Menus

The **User Management** menu offers the following option:

- **Template Management**—allows you to download templates, update a template status, or view last downloaded templates.

The **System Management** menu offers the following option:

- **Help**—displays the Customer Support telephone number and allows user to issue a support ticket.



10

TROUBLESHOOTING

See the following table for help with the error messages that you might encounter with your BN Series Time Clock.

ERROR MESSAGE	NOTES
NET NOT FOUND	This message displays if the time clock is not currently plugged into any networking device, or the networking device it is plugged into is turned off or is not functioning correctly.
SORRY, DEALER ID NOT FOUND	TrackMyTime.com will report this error if the Dealer ID you entered is not valid. Please contact your dealer representative for assistance.
UNSUCCESSFUL LOGIN	When you attempt to log in to TrackMyTime.com, the login form refreshes. This indicates that the username/password combination that you entered was not correct. If you have forgotten your username and/or password, click on the Email username/password link at the top of the page.
SORRY, USER NOT FOUND	This message displays if a user attempts to punch in, but their fingerprint ID or PIN number has not been assigned to their user profile.

SORRY, USER NOT VERIFIED	This message displays if a user attempts to punch in, but their fingerprint template has not been registered.
uAttend CONNECTIVITY ERROR	This message displays if the time clock is unable to communicate with the uAttend server due to a firewall, content filter, or any other type of network block.
INTERNET CONNECTIVITY ERROR	This message displays if the time clock is unable to communicate out of the local network onto the Internet.
DNS ERROR	This message displays if the time clock does not have a valid DNS server IP address to contact, or the DNS server it is contacting cannot properly resolve the host name for the server.
DHCP ERROR	This message displays if the time clock does not receive proper IP address information provided to it from the DHCP server.
DHCP UNAVAILABLE	This message displays if the time clock receives no response when attempting to contact a DHCP server.

**11**

TEMPLATE ASSIGNMENT SHEET

Make copies of this page for additional employees, if needed.

EMPLOYEE NAME	FINGERPRINT ID

EMPLOYEE NAME	FINGERPRINT ID

CHARACTER TABLES

To join a WiFi network (BN6500 and BN6600 models only), you will use the numeric keypad to enter numbers, letters, and symbols for your password. The following tables display the keys you will use to enter each letter or symbol.

Switching To Numbers

To enter numbers press the ESC key once. To return to letters, press the check mark ✓ key until the bar at the bottom of the screen says “English.”

Entering Symbols

To enter symbols press the check mark ✓ key until it says “symbol” and enter the appropriate numerical and key patterns for the symbol desired.

Saving the Password

Once you have added your WiFi password, ensure that you are in number entry mode, then press **OK** to enter.

NOTE: To access the number entry mode, press the **ESC** key once from the letter or symbol entry mode.

Your WiFi password will display at the top of the screen and you will be asked to press **OK** again to confirm that it is correct. If not, go back.

Press the **ESC** key until you are back to the main screen. Your screen will display “System Ready” in green once your password has authenticated.

LETTER	KEYS	LETTER	KEYS
a	20	A	23
b	21	B	24
c	22	C	25
d	30	D	33
e	31	E	34
f	32	F	35
g	40	G	43
h	41	H	44
i	42	I	45
j	50	J	53
k	51	K	54
l	52	L	55
m	60	M	63
n	61	N	64
o	62	O	65
p	70	P	74
q	71	Q	75

LETTER	KEYS	LETTER	KEYS
r	72	R	76
s	73	S	77
t	80	T	83
u	81	U	84
v	82	V	85
w	90	W	94
x	91	X	95
y	92	Y	96
z	93	Z	97

NOTE: You must press the ✓ key to access the symbol mode from alpha mode.

SYMBOL	KEYS	SYMBOL	KEYS
[spacebar]	0	:	PIN 8
~	1	"	PIN(x2) 0
!	2	<	PIN(x2) 1
@	3	>	PIN(x2) 2
#	4	?	PIN(x2) 3
\$	5	`	PIN(x2) 4
%	6	-	PIN(x2) 5
^	7	=	PIN(x2) 6
&	8	[PIN(x2) 7
*	PIN 0]	PIN(x2) 8
(PIN 1	\	PIN(x3) 0
)	PIN 2	;	PIN(x3) 1
_	PIN 3	'	PIN(x3) 2
+	PIN 4	,	PIN(x3) 3
{	PIN 5	.	PIN(x3) 4
}	PIN 6	/	PIN(x3) 5
	PIN 7		



13

uATTEND DEVICE LIMITED WARRANTY

This Warranty covers all uAttend™ Devices and any Devices which may now or in the future be connected to your uAttend Account.

- A. **Warranty and Warranty Periods.** Processing Point, Inc. (“PPoint”) warrants only to the original Purchaser that the Device will be free from defects in material and workmanship for the time during which (i) the original Purchaser subscribes to the uAttend System, and (ii) until such time the Device has been replaced (the “Warranty Period”).
- B. **PPoint’s Obligation Under Warranty.** PPoint’s sole obligation under the above warranty shall be to repair or replace Devices and parts during the Warranty Period. PPoint does not assume responsibility for delays in replacement or repair of products or parts. PPoint may, at its sole discretion, replace Devices with refurbished Devices. This warranty gives end users specific legal rights, and particular end users may also have other rights which may vary from jurisdiction to jurisdiction.
- C. **DISCLAIMER OF ALL OTHER WARRANTIES.** NO OTHER WARRANTIES, EXPRESSED OR IMPLIED, ARE GIVEN, AND PPOINT EXPRESSLY DISCLAIMS ALL OTHER WARRANTIES, INCLUDING AND WITHOUT LIMITATION, THE IMPLIED WARRANTIES OF MERCHANTABILITY AND FITNESS FOR A PARTICULAR PURPOSE. Some jurisdictions do not allow limitations on how long an implied warranty lasts, so the above limitation may not apply to particular end users.

- D. **Limitations.** No salesperson, representative, or agent of PPoint is authorized to make any guaranty, warranty, or representation that contradicts the terms contained in this Limited Warranty. Any waiver, alteration, addition, or modification to the warranties contained herein must be in writing and signed by authorized representatives of PPoint to be valid, binding, and enforceable. PPoint does not assume responsibility for any specific application to which any products or parts are applied including, but not limited to, compatibility with other equipment. All statements, technical information, or recommendations relating to the products or parts are based upon tests believed to be reliable, but do not constitute a guaranty or warranty. PPOINT SHALL NOT UNDER ANY CIRCUMSTANCES WHATSOEVER BE LIABLE TO ANY PARTY FOR LOSS OF PROFITS, DIMINUTION OF GOOD WILL, OR ANY OTHER SPECIAL, CONSEQUENTIAL, OR INCIDENTAL DAMAGES WHATSOEVER WITH RESPECT TO ANY CLAIM IN CONNECTION WITH PPOINT PRODUCTS AND/OR PARTS. Some jurisdictions do not allow the exclusion or limitation of incidental or consequential damages, so the above limitation or exclusion may not apply to particular end users.
- E. **What May Void the Warranty.** This Limited Warranty shall be null and void in the following circumstances:
1. Modification or repair by the end user or any non-authorized PPoint service provider; or
 2. Improper use or installation, or damage by accident or neglect, by the end user or any third party, or intentional damage by the end user or any third party; or

3. Failure of the end user or any third party to exercise caution to protect from electrostatic discharge damage and adverse temperature, or physical abuse; or
 4. Failure by the end user to follow the Return Appointment Process set forth below.
- F. Return Appointment Process. As a condition precedent to the above Limited Warranty, the end user must:
1. Obtain a return material authorization (RMA) from PPoint, which will include an RMA number that must be prominently displayed on the outside of the shipping container. Returns without an RMA number may be rejected by PPoint and immediately returned to end user, freight collect.
 2. Ship the items being returned to PPoint, freight prepaid, together with a written description of the claimed defect.
 3. Pack the items being returned in the original packing carton or equivalent. Damage in transit is end user's responsibility and may be cause to void the warranty claim.
- G. Transportation Costs. PPoint will pay surface freight to return products covered by this Limited Warranty. However, if PPoint determines in the exercise of its reasonable but sole discretion that the product or part returned for warranty service is not defective, or does not otherwise qualify for warranty service, the end user shall be liable for all costs of handling and transportation.



14

ATTEND SAFETY INFORMATION

IMPORTANT SAFEGUARDS FOR SAFE OPERATION & USE

SAVE THESE INSTRUCTIONS.

THIS PRODUCT IS FOR COMMERCIAL USE ONLY.

The time clock is an electrical device. In order to reduce the risk of fatal electrical shock and fire, basic safety precautions should be followed, including the following:

1. Read all instructions before operating.
2. This time clock must be properly installed and located in accordance with these instructions before used.
3. Do not use outdoors.
4. Do not expose to water or any liquid.
5. Do not place objects into the time clock.
6. For best operation, plug the time clock into its own electrical outlet.
7. Do not operate the time clock with a damaged cord or plug.
8. If an extension cord is used, the marked electrical rating of the extension cord should be at least as great as the electrical rating of the time clock.
9. Plug the time clock into a surge protector or uninterruptible power supply (UPS). If a surge protector is not used and there is a power surge, your warranty may be voided.



CAUTION/WARNING



DANGEROUS VOLTAGE



DO NOT CONNECT
DAMAGED SUPPLY CORD

WARNING

RISK OF FIRE OR ELECTRIC SHOCK
DO NOT OPEN

WARNING: TO REDUCE THE RISK OF FIRE OR ELECTRIC SHOCK, DO NOT OPEN THE TIME CLOCK. NO USER SERVICEABLE PARTS ARE INSIDE. REPAIRS SHOULD BE COMPLETED BY AUTHORIZED SERVICE PERSONNEL ONLY.

Questions?

Contact us seven days a week.

Monday-Friday 5am-6pm Pacific | Saturday-Sunday 7am-3:30pm Pacific



Call

800-518-8925



Text

760-278-6623



Email

support@trackmytime.com



Visit

support.trackmytime.com

uAttend™

Cloud Connected Time & Attendance System

workwell
TECHNOLOGIES

Designed, Developed, and Supported by Workwell Technologies, Inc.
© Workwell Technologies, Inc. All rights reserved.
2777 Loker Avenue Suite A Carlsbad CA 92010
workwelltech.com

Rev. 03/2019