

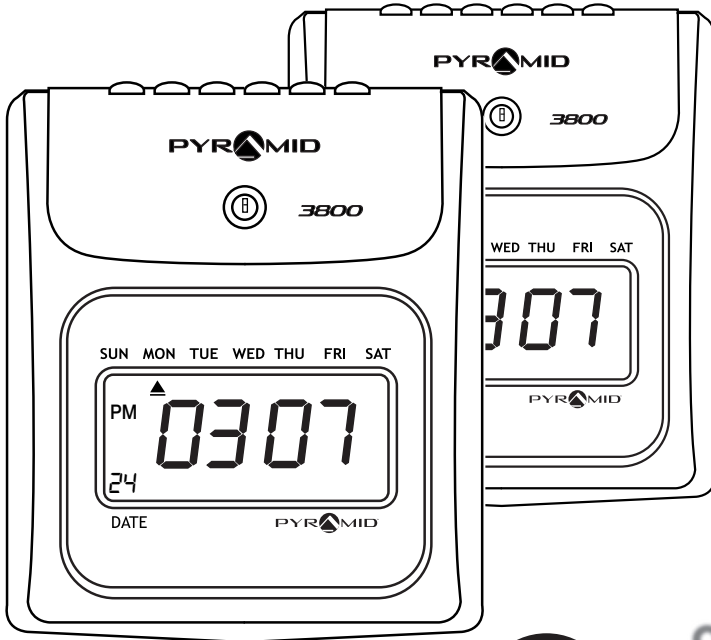

3800

Auto Totaling Time Clock

User Guide



AUTO TOTALING TIME CLOCK INSTRUCTIONS
Model 3800

Don't Forget: Register your product online:
www.pyramidthetimesystems.com/support/product-registration

Copyright Information

© 2021 Pyramid, LLC. All rights reserved.

Reproduction, adaptation or translation without prior written permission is prohibited, except as allowed under the copyright laws.

The information contained herein is subject to change without notice. The only warranties for Pyramid are set forth in the express warranty statements accompanying such products. Nothing herein should be construed as constituting an additional warranty. Pyramid shall not be liable for technical or editorial errors or omissions contained herein.

TABLE OF CONTENTS

PRODUCT OVERVIEW 2

FEATURES 2

CONTENTS 3

WALL MOUNTING 4

PROGRAMMING 5-11

TIME CARD & PRINT FORMAT 12

REPLACING RIBBON CARTRIDGE 13

TROUBLESHOOTING & PRINT ADJUSTMENT 14

ACCESSORIES 14

MASTER RESET 15

CUSTOMER SUPPORT 16

SPECIFICATIONS 16

MOUNTING TEMPLATE 17

WARRANTY 18

AUTO TOTALING TIME CLOCK INSTRUCTIONS

Model 3800

PRODUCT OVERVIEW

Thank you for choosing a **3800 Auto Totaling Time Clock!**

The 3800 features automatic employee time totaling for accurate, error-free payroll tracking. Total weekly, every 2 weeks or bi-monthly pay periods for up to 50 employees. Simple set-up, simple operation and simple ribbon changes make this time clock a favorite with small business!

Please read through this User Guide for simple set-up and operation.

AUTO TOTALING TIME CLOCK : FEATURES

Employee Capacity	50
Card Alignment	Top
Auto Totaling	Yes
Pay Period	Weekly, every 2 weeks, bi-monthly
Punch Rounding	0, 5, 10 or 15 minute intervals
Ribbon Ink	Black
Bell Interface	No
Wall Clock Interface	No
Language Printing	English
Display	Time, Date and Day of Week, backlit LCD screen
Printing Format	Date, Time (select AM/PM, military or true military)
Printing	Dot matrix
Automatic Time Reset	Short months, Leap Year and Daylight Saving Time USA
Battery Back-Up	Safeguards data and SETTINGS for up to 30 days without power
Tamper-Proof	Security lock protects against costly time theft
Warranty	1-Year manufacturer's limited warranty

AUTO TOTALING TIME CLOCK INSTRUCTIONS

Model 3800

CONTENTS

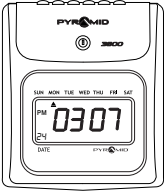

3800 Auto Totaling Time Clock

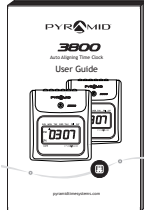

3800 User Guide



50 Time Cards



Mounting Template
(see page 17)

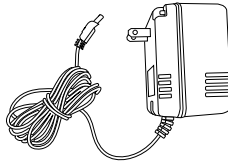

Power Adapter



Security Keys (2)

WHAT YOU WILL NEED

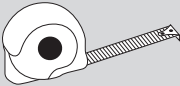

Tape Measure



Pencil



Screw Driver

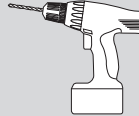

Power Drill
(Optional)



#10 Screw (2)
(2) Plastic Anchors

KNOW YOUR SERIAL

IMPORTANT:
Please write down serial #
located on back of time
clock before mounting.

Write your
serial # here: 

--	--	--	--	--	--	--	--	--	--	--	--	--	--	--	--	--	--	--	--	--

Model 3800 U.L. LISTED POWER SUPPLY
Auto Totaling Time Clock INPUT: 12.5V 1.5A



45 Gracey Avenue
Meriden, CT 06451
888.479.7264
www.pyramidthimesystems.com
00000000

Made in China
L4981

AUTO TOTALING TIME CLOCK INSTRUCTIONS

Model 3800

DESKTOP SET UP

- ① Remove time clock from carton and place on a flat, level surface.
- ② Plug unit into AC wall outlet.

WALL MOUNTING

- ① Select a location convenient to employees clocking IN and OUT. Be sure power outlet is within 4 feet of mounting location.
- ② Use masking tape to hold mounting template (located on last page) on wall, making certain template is positioned so bottom of time clock is approximately 45 inches from floor.
- ③ Drill holes using template as a guide.
- ④ Remove template from wall and install #10 screws, leaving approximately $\frac{3}{16}$ inch of screws exposed. For sheetrock walls, use plastic anchors.
- ⑤ Hang time clock on wall, aligning keyholes on the rear with screw heads. Press downward on time clock until it lowers onto screws.
- ⑥ Plug unit into AC wall outlet.
- ⑦ It is recommended to remove the clock from bracket to complete programming set up which begins on page 5.

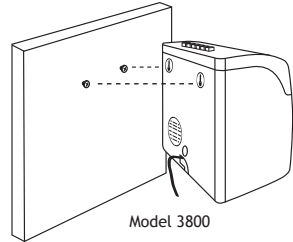

AUTO TOTALING TIME CLOCK INSTRUCTIONS

Model 3800

PROGRAMMING

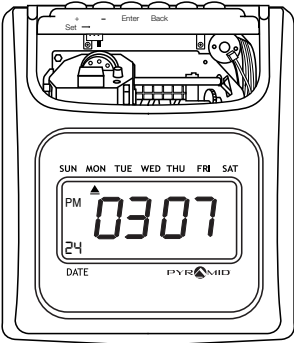

Use the key to unlock and remove top/front cover.

BUTTONS

SET	Activates SET Mode (right) or Operation Mode (left).
Button 1 (+)	Scroll Up
Button 2 (-)	Scroll Down
Button 3 (Enter)	Saves current or new setting and advances to next function.
Button 4 (Back)	Previous SETTING Mode.
Button 6+5+1	Master reset. Reset time clock to factory default settings

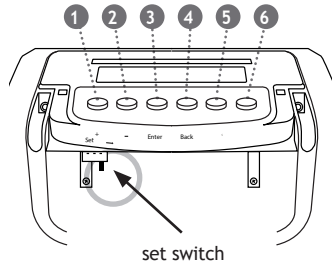

DISPLAY/BUTTONS

01	Indicates active SET mode or function
----	---------------------------------------

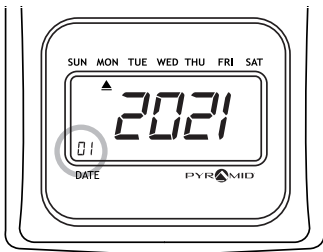

AUTO TOTALING TIME CLOCK INSTRUCTIONS

Model 3800

PROGRAMMING

To activate SET mode, slide the black “SET” switch to the right.

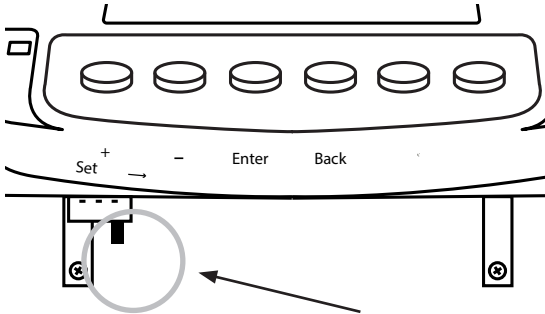

01-SET YEAR

- ① The default SETTING is current year.
- ② In SET mode, press “+” or “-” to change current year.
- ③ Press “ENTER” to confirm.
- ④ The SET mode advances to “02”.
- ⑤ Continue to next steps or slide the “SET” switch to the left to exit SETTING mode.



02-SET DATE

- ① In SET mode, press “+” or “-” to advance to current month.
- ② Press “ENTER” to confirm.
- ③ In SET mode, press “+” or “-” to advance to current date.
- ④ Press “ENTER” to confirm.
- ⑤ The SET mode advances to “03”.
- ⑥ Continue to next steps or slide the “SET” switch to the left to exit SET mode.



AUTO TOTALING TIME CLOCK INSTRUCTIONS

Model 3800

03-SET PRINT & DISPLAY TIME FORMAT

This function sets the time clock to display and print time in either AM/PM (12 hour) or Military time (24 hour).

- ① In SET mode, press “+” or “-” to select “12” for AM/PM or “24” for Military time.
- ② Press enter to confirm.
- ③ The SET mode advances to “04”.
- ④ Continue to next steps or slide the “SET” switch to the left to exit SET mode.

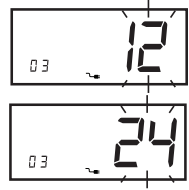

04-SET TIME

- ① In SET mode, press “+” or “-” to advance or subtract hour.
- ② Press “ENTER” to confirm.
- ③ In SET mode, press “+” or “-” to advance or subtract minute.
- ④ Press “ENTER” to confirm.
- ⑤ The SET mode advances to “05”.
- ⑥ Continue to next steps or slide the “SET” switch to the left to exit SET mode.

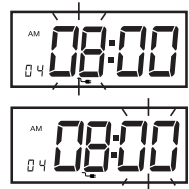

05-SET MINUTE PRINT FORMAT

This function sets how the minutes will print on the time card.

- ① In SET mode, press “+” or “-” to select desired printing mode. 60-standard minutes (60 minute format) 100-minutes in hundredths (ie. 12:45 will print as 12:75)
- ② Press “ENTER” to confirm.
- ③ The SET mode advances to “06”.
- ④ Continue to next steps or slide the “SET” switch to the left to exit SET mode.

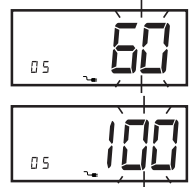

06-SET DAYLIGHT SAVING TIME

This feature sets the time clock to automatically adjust the time for USA Daylight Saving Time.

- ① In SET mode, press “+” or “-” to select desired Daylight Saving Time mode. 01-Automatic DST, 00-No DST.
- ② Press “ENTER” to confirm.
- ③ The SET mode advances to “07”.
- ④ Continue to next steps or slide the “SET” switch to the left to exit SET mode.

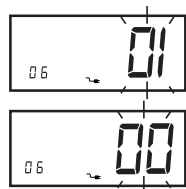

AUTO TOTALING TIME CLOCK INSTRUCTIONS

Model 3800

07-SET THE PAY PERIOD

This function sets the desired pay period.

- ① In SET mode, press “+” or “-” to select the desired pay period. 01-weekly, 02-every 2 weeks, 03-bi-monthly.
- ② Press “ENTER” to confirm.
- ③ The SET mode advances to “08”.
- ④ Continue to next steps or slide the “SET” switch to the left to exit SET mode.



08-SET PAY PERIOD START DATE

This function sets the day on which the pay period will start. If **weekly** pay period, select the day on which the pay period will start.

- ① In SET mode, press “+” or “-” to select day. 00-Sunday, 01-Monday, 02-Tuesday, 03-Wednesday, 04-Thursday, 05-Friday, 06-Saturday.
- ② Press “ENTER” to confirm.
- ③ The SET mode advances to “09”.
- ④ Continue to next steps or slide the “SET” switch to the left to exit SET mode.



NOTE: Weekly pay allows both sides of the card to be used. One side for Week 1 and the other side for Week 2

If **every 2 weeks** pay period, select the month and date on which the first pay period will start.

- ① In SET mode, press “+” or “-” to select the month.
- ② Press “ENTER” to confirm.
- ③ In SET mode, press “+” or “-” to select the date.
- ④ Press “ENTER” to confirm.
- ⑤ The SET mode advances to “09”.
- ⑥ Continue to next steps or slide the “SET” switch to the left to exit SET mode.



If **bi-monthly** pay period, the time clock will automatically reset on the 1st and 16th of each month.



AUTO TOTALING TIME CLOCK INSTRUCTIONS

Model 3800

09-SET DAY LINE CHANGE TIME (Pay period reset time)

This function allows you to set the time of the day the time clock will advance to the next day/row on the time card (default SET 12am). For example, if your company has a shift beginning at 8am, it is recommended to set the row advance time for 6am to ensure employees punching in will have all in/out punches in the same row on the time card.

- ① In SET mode, press “+” or “-” to advance or subtract hour.
- ② Press “ENTER” to confirm.
- ③ In SET mode, press “+” or “-” to advance or subtract minute.
- ④ Press “ENTER” to confirm.
- ⑤ The SET mode advances to “10”.
- ⑥ Continue to next steps or slide the “SET” switch to the left to exit SET mode.

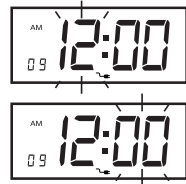

10-SET PUNCH ROUNDING

This function sets the punch rounding rules. Rounding rules are used on all punches, however the clock will punch the actual time and ONLY the cumulative time is rounded including the Daily OT if applicable.

00-No Rounding - calculates the In/Out totals and running total using the actual clock in/out times.

01-5 Minute Rule - In/Out and running totals are rounded to nearest 5-minute mark. For example, if an employee punches in at 8:02, the punch is rounded to 8:00. If an employee punches in at 8:03, the punch is rounded up to 8:05.

02-10 Minute Rule - In/Out and running totals are rounded to nearest 10 minute mark with a cutoff of 5 minutes. For example, if an employee punches in at 8:04 the punch is rounded down to 8:00, if an employee punches in at 8:05, the punch is rounded up to 8:10.

03-15 Minute Rule - In/Out and running totals are rounded to nearest 15-minute mark. For example if an employee punches in at 8:05, the punch is rounded down to 8:00. If an employee punches in at 8:08, the punch is rounded up to 8:15.

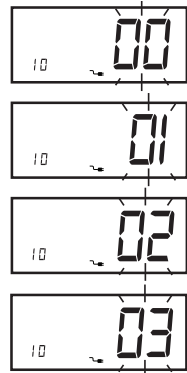

- ① In SET mode, press “+” or “-” to select the desired punch rounding rules.
- ② Press “ENTER” to confirm.
- ③ The SET mode advances to “11”.
- ④ Continue to next steps or slide the “SET” switch to the left to exit SET mode.

AUTO TOTALING TIME CLOCK INSTRUCTIONS

Model 3800

11-SET DAILY OVERTIME (OT start line)

This function enables you to choose the number of hours that take place before the daily time is considered overtime. The default SET is 08:00.

- ① In SET mode, press “+” or “-” to select the hour.
- ② Press “ENTER” to confirm.
- ③ In SET mode, press “+” or “-” to select the minutes.
- ④ Press “ENTER” to confirm.
- ⑤ The SET advances to “12”.
- ⑥ Continue to next steps or slide the “SET” switch to the left to exit SET mode.



12-SET MAXIMUM NUMBER OF HOURS ALLOWED BETWEEN IN/OUT PUNCHES

This feature sets the number of hours allowed between punches to guard against employees who forget to punch out. For example, if 13 hours is selected, an employee punches in, forgets to punch out, the clock prints the next line as an “In punch” if more than 13 hours have elapsed. The time card will show the “In” punch followed below by a space where the “Out” punch would have been located and then followed by the correct “In” punch. Hours can be set from 00-99. The default is set at 13 hours.

- ① In SET mode, press “+” or “-” to select the hour.
- ② Press “ENTER” to confirm.
- ③ Slide “SET” switch to the left to exit SET mode.

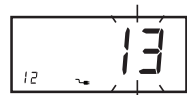

CHANGING A SET MODE

- ① Slide the “SET” switch to right.
- ② In SET mode, press “ENTER” to select the SET mode to be changed.
- ③ Follow the instructions for the selected feature.
- ④ Slide the “SET” switch to the left when complete.

AUTO TOTALING TIME CLOCK INSTRUCTIONS

Model 3800

Advanced Features

The following features are preset at the factory and should not need adjustment unless the printing needs adjustment.

13 - UP/DOWN PRINTING POSITION ADJUSTMENT

This function adjusts the printing position up or down on the time card. The default is set at 05.

- ① In **SET** mode, advance to mode 13.
- ② Press “+” or “-” to select from 00 (down) to 09 (up).
- ③ Press “**ENTER**” to confirm.
- ④ The SET advances to “14”.
- ⑤ Continue to next steps or slide the “**SET**” switch to the left to exit SET mode.

14 - LEFT/RIGHT PRINTING POSITION ADJUSTMENT

This function adjusts the printing position left or right on the time card. The default is set at 05.

- ① In **SET** mode, advance to mode 14.
- ② Press “+” or “-” to select from 00 (left) to 09 (right).
- ③ Press “**ENTER**” to confirm.
- ④ Slide “**SET**” switch to the left to exit SET mode.

AUTO TOTALING TIME CLOCK INSTRUCTIONS

Model 3800

TIME CARDS

Use only time card 3800-10 by Pyramid. Using time cards other than Pyramid item 3800-10 voids the warranty.

Time Card 3800-10

PYRAMID						A 001
Name _____						
No. _____ Period _____						
Regular Hours _____ Rate _____ Amount _____						
Overtime Hours _____ Rate _____ Amount _____						
Deduction _____ Actual Pay _____ Pay Date _____						
TOTALS						
DATE	IN	OUT	DAILY	CUMULATIVE	DAILY OT	
①	②	③	④	⑤	⑥	⑦
EMPLOYEE SIGNATURE _____						3800-10 Made in China
pyramidtime.com © 2021 PYRAMID TIME SYSTEMS, LLC						China

PYRAMID						A 001
Name _____						
No. _____ Period _____						
Regular Hours _____ Rate _____ Amount _____						
Overtime Hours _____ Rate _____ Amount _____						
Deduction _____ Actual Pay _____ Pay Date _____						
TOTALS						
DATE	IN	OUT	DAILY	CUMULATIVE	DAILY OT	
①	②	③	④	⑤	⑥	⑦
EMPLOYEE SIGNATURE _____						3800-10 Made in China
pyramidtime.com © 2021 PYRAMID TIME SYSTEMS, LLC						China

FRONT

TIME CARD PRINT FORMAT

DATE	IN	OUT	DAILY	CUMULATIVE	DAILY OT
30 NOV	8:02A	12:00P	3:58	3:58	0:00
30 NOV	12:40P	4:31P	3:51	7:49	0:00



If time clock prints incomplete characters, the ribbon is not fully installed over print head. If time clock prints lines that become increasingly light, the cartridge is not fully snapped into the holder. Reinstall ribbon cartridge, following steps 1-11 (page 13) until a complete and consistent time card prints.

For assistance, please contact customer support at 888.479.7264.

AUTO TOTALING TIME CLOCK INSTRUCTIONS

Model 3800

REPLACING RIBBON CARTRIDGE

For optimum performance, replace ribbon cartridge every 6 months.

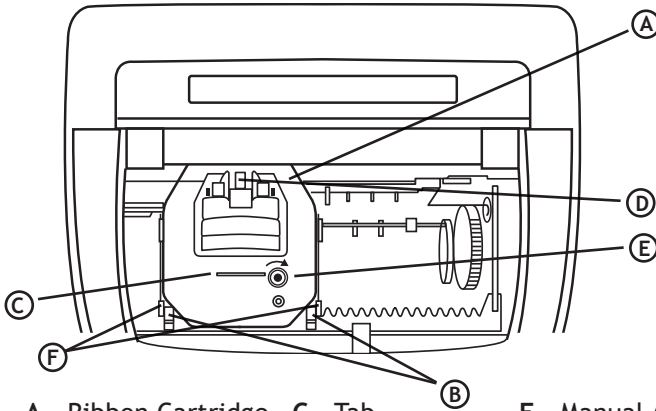

A - Ribbon Cartridge C - Tab E - Manual Advance Knob
B - Clips D - Ribbon Guide F - Retaining Pins

- ① Use only genuine Pyramid product part #43079 Replacement Ink Ribbon Cartridge.
- ② Unlock and remove the time clock cover.
- ③ Prior to removing old ribbon, slide "SET" switch to the right. **CAUTION: Do not attempt to change the ribbon when in operation mode, as this may result in injury.**
- ④ To remove old ribbon, pull two clips (B) towards you and simultaneously lift ribbon cartridge, pull straight up using tab (C) located on top of cartridge.
- ⑤ Remove new ribbon cartridge from packaging and turn the manual ribbon advance knob (E) clockwise to straighten ribbon.
- ⑥ Holding tab (C) install ribbon cartridge into print carriage, making certain to lower the ribbon in front of the ribbon guide (D) first, then make certain retaining pins (F) are within clips (B) (see diagram).
- ⑦ Gently push down cartridge until it snaps into carriage while turning the manual ribbon advance knob clockwise.
- ⑧ Turn manual ribbon advance knob clockwise a few rotations to ensure ribbon is positioned correctly in front of print head.
- ⑨ Slide "SET" switch to the left.
- ⑩ Replace the cover and lock unit.
- ⑪ Feed a time card through unit to test print quality.

AUTO TOTALING TIME CLOCK INSTRUCTIONS

Model 3800

TROUBLESHOOTING

TIME CARD MISFEED

In the event the time card will not feed, re-feed the time card. If issue persists, please check list for possible causes:

TIME CARD MISFEED

POSSIBLE CAUSES	ACTION
Time card inserted too hard into time clock	Re-Feed Card
Time card held too long	Re-Feed Card
Time card inserted into time clock on an angle	Re-Feed Card
Time card is wet or damaged	Use new time card
Time card inserted wrong (side A or B) for Every 2 weeks and Bi-monthly employee	Refeed card using correct side

NO PRINTING

PROBABLE CAUSE	ACTION
Over 50 employees/time card limit	Do not exceed over 50 employees/time cards

IMPAIRED PRINTING

SYMPTOM	PROBABLE CAUSE	ACTION
Time card feeds with no printing	Ribbon not installed properly	Check that ribbon cartridge is properly installed. See page 13.
Punches print outside of column	Print needs adjustment	Follow Print Adjustment. (Mode 14) Instructions on page 11.

ACCESSORIES

3800 : ACCESSORIES

ITEM #	DESCRIPTION
43079	Replacement Ink Ribbon Cartridge
3800-10	Time Cards (100pk)
3800K	Replacement Keys (2)
400-10	10 Capacity Time Card Rack

To order accessories visit pyramidtimesystems.com, call 888.479.7264.

AUTO TOTALING TIME CLOCK INSTRUCTIONS

Model 3800

MASTER RESET

Erases time clock's memory and restores default factory SETs.

- ① Unlock and remove time clock cover.
- ② Slide SET switch to right for SET mode.
- ③ In SET mode press the 6th, 5th and 1st buttons at the same time.
- ④ Re-program time clock.

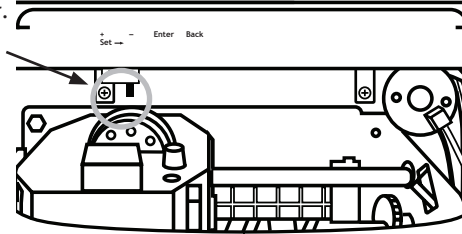

DEFAULT SETS

MODE	FUNCTION	DEFAULT SET
01	Year	Current
02	Month and Date/Day	Current
03	Print and Display Time Format	12 (AM/PM)
04	Time (HR,MIN)	Current
05	Minute Print Format	60 (Hr = 60 min)
06	Daylight Savings Time	01 (DST USA)
07	The Pay Period	01 (Weekly)
08	Pay Period Start Date	00 (Sunday)
09	Pay Period Reset Time	12:00 (12AM)
10	Punch Rounding	00 (No Rounding)
11	Daily Overtime/OT Start Line	08:00 (8 Hrs)
12	Max Number of Hrs Allowed Between In/Out Panches	13 (13 Hrs)
13	Up/Down Printing Position Adjustment	05 (Middle)
14	Left/Right Printing Position Adjustment	05 (Middle)

NOTE: Master Reset will not reset SETTINGS 01, 02 or 04. They will always keep the current SETTINGS unless you change them. All other SETTINGS will return to the default SETTINGS.

AUTO TOTALING TIME CLOCK INSTRUCTIONS

Model 3800

SPECIFICATIONS

3800 : SPECIFICATIONS

OPERATING CONDITIONS	
Temperature	0 °C - 50 °C, 32 °F - 122 °F
Humidity	10-95% RH, non condensing
POWER FAILURE	
Battery Back-Up	30 Days, Data and Time
Battery Life	10 Years
CALENDAR	Automatic Leap Year and Daylight Saving Time USA or No DST
CLOCK ACCURACY	Less than 30 seconds/year
POWER	100-240 V AC, 50/60 Hz
CERTIFICATIONS	UL and CUL, Power Supply
WEIGHT	3.05lbs
DIMENSIONS	7¼"W" x 8½"H x 4½"D
MOUNTING	Desktop or Wall

CONTACT US:

For more information, visit pyramidthimesystems.com or call customer care at **888.479.7264** during regular business hours:
8:30am-5pm EST, M-F.

Copyright © 2021 Pyramid, LLC. All rights reserved.

I2283



3800 MOUNTING TEMPLATE

Screw Guide Template Below Is Actual Size

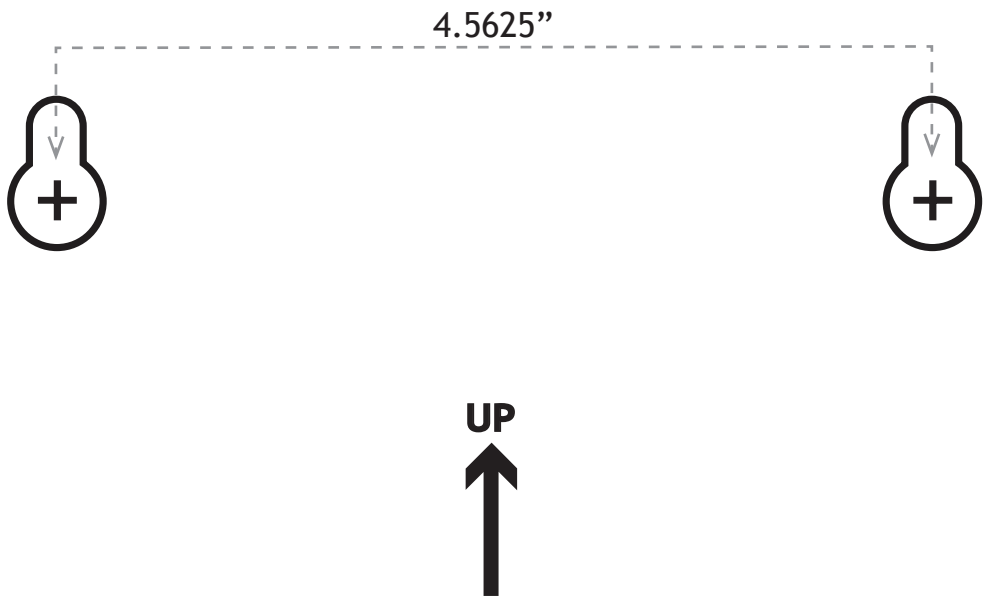

LEVEL LINE MARKER

AUTO TOTALING TIME CLOCK INSTRUCTIONS

Model 3800

LIMITED HARDWARE WARRANTY

- Pyramid Time Systems warrants its equipment to original user against defective material or workmanship for a period of 1-year from date of purchase. Proof of purchase and purchase date are required for warranty service on this product.
- Pyramid Time Systems responsibility under this warranty is limited to replacement of defective part(s). Replacement is the sole discretion of Pyramid Time Systems.
- For Return Shipments to Pyramid Time Systems, product must be shipped in its original carton or equivalent. The return freight method and cost for warranted product is the sole responsibility of the customer. Pyramid Time Systems will not assume any responsibility for loss or damage incurred in shipping.
- Pyramid Time Systems reserves the right to determine whether parts failed because of defective material, workmanship or other causes.
- Failure caused by accident, alteration, misuse or improper packaging of returned unit is not covered by this warranty.
- Any repair done by the customer without the consent from Pyramid Time Systems will automatically void the warranty.
- Users in countries other than Canada and USA should contact the Dealer from whom the unit was purchased.
- The rights under this warranty are limited to the original user and may not be transferred to subsequent users.

MONEY BACK GUARANTEE

Pyramid Time Systems offers a 30-day money back guarantee. If an RMA is issued for an unwanted product before 30 days, Pyramid Time Systems will refund the entire purchase price less shipping if purchased from Pyramid Time Systems. Pyramid Time Systems will assess a 15% restocking fee on any returns received between 31 and 60 days from the date of purchase. No returns will be accepted after 60 days. Pyramid Time Systems will not issue a call tag for pickup of products. Customers are responsible for shipping the product back including the cost of shipping. Pyramid Time Systems will assume the cost of ground shipping for the replacement product to the customer. Pyramid Time Systems will also assess a 15% fee if any item(s) are missing in an open box return. Shipping back to Pyramid Time Systems from a Pyramid Time Systems Partner is the responsibility of the Pyramid Time Systems Partner. No call tags will be issued. Items returned to Pyramid Time Systems without an RMA will not be credited.