



TO PLACE AN ORDER CALL: 866-487-4751  
OR VISIT: WWW.TIMECLOCKEXPERTS.COM

**AMANO**<sup>®</sup>

# TCX-21

**Electronic Time Clock**

**Operation Manual**



TO PLACE AN ORDER CALL: 866-487-4751  
OR VISIT: WWW.TIMECLOCKEXPERTS.COM

---

***Thank you...***  
for purchasing another fine product from  
Amano Cincinnati, Inc.

### **Important**

Note that the government standard for DST is subject to change. Your clock is factory-set for correct DST based upon when it was manufactured, but any revision to DST begin or end dates may require updating the system-set DST calendar.

If you live in Arizona, Hawaii, parts of Indiana, or any other area that does not use Daylight Saving Time, refer to this document's DST settings instruction for details regarding disabling the DST function.

Do not return this clock to the retailer. If you have any questions or need assistance, please call us toll free at:

**1-800-253-9836**

### **Proprietary Notice**

This document contains proprietary information and such information may not be reproduced in whole or part without the written permission from Amano Cincinnati, Inc., 140 Harrison Ave., Roseland, New Jersey, 07068.

Amano Cincinnati, Inc. reserves the right to make equipment changes and improvements, which may not be reflected in this document. Portions of this document may have been updated to include the latest hardware or firmware version, if applicable.

We recommend that this document be read in its entirety before any attempt is made to operate the equipment.

Need Ribbons, Keys and Accessories?  
Visit

**[www.amano.com](http://www.amano.com)**

or

Call - (800)-253-9836

---

---

## Specifications

Power Requirements:	AC100V $\pm$ 10%, 50/60Hz AC120V $\pm$ 10%, 60Hz AC230V $\pm$ 10%, 50/60Hz
Ambient Temperature:	-10°C to 45°C (14°F to 113°F)
Ambient Humidity:	10% to 90% (non-condensing)
Dimensions:	6 7/8" (175 mm) wide x 8 1/4" (210 mm) high x 6 1/4" (159 mm) deep
Weight:	3.196 Kg (7 lbs.)
Environment:	Indoor use only; dust-free environment. Keep out of direct sunlight.

## External View

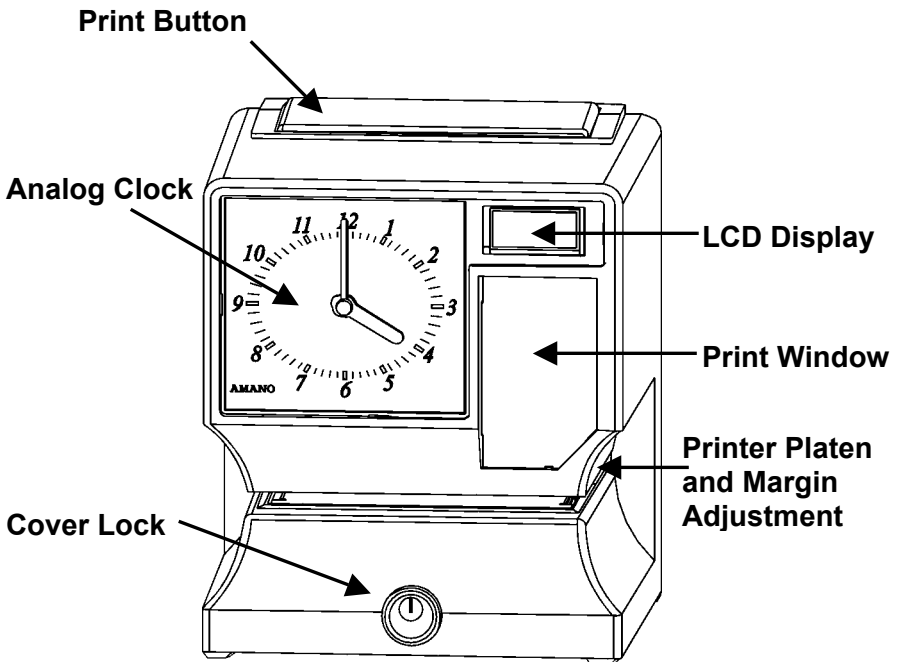

---

## Removing the Cover & Packing Material

1. Turn the key clockwise to unlock the cover.
2. Lift the cover up, then pull it towards you to remove it.
3. Lift the printer block and remove the spacer.
4. Remove the spacer between the Ribbon Cartridge and the Printer Carriage Tab.
5. Reinstall the cover of your unit.

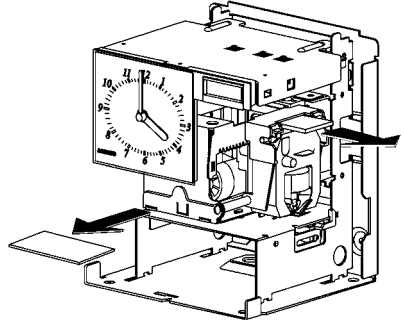
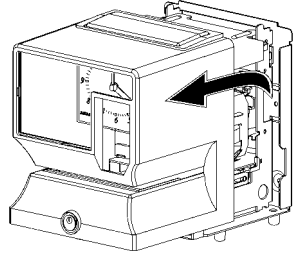

## Internal View

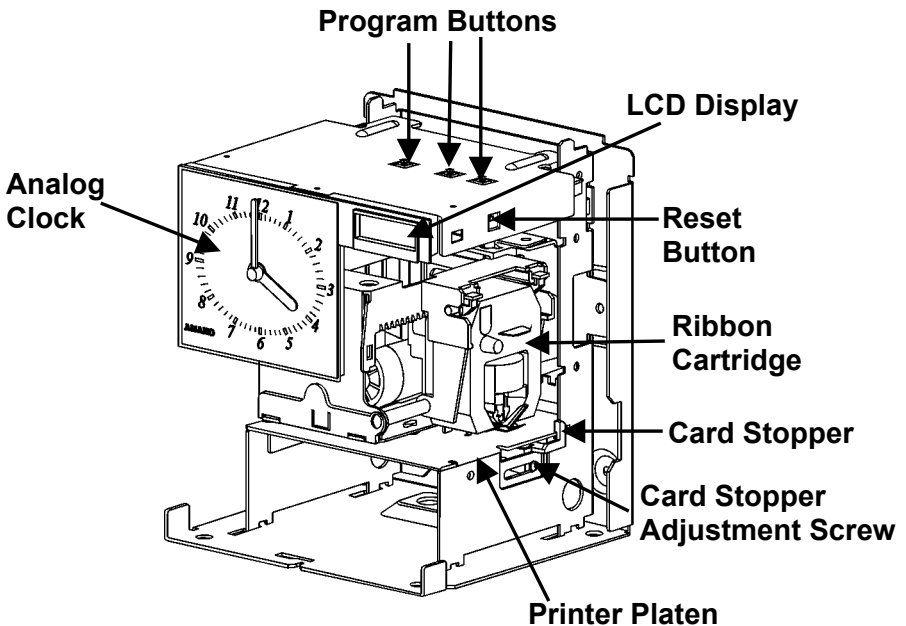

---

## Power Connection

Before connecting power, verify that the AC outlet voltage falls in the range of 100-240 Volts AC and that the power cord and plug are appropriate for your AC source. Plug the power cord into a properly grounded 120 or 240 Volt wall outlet.

## Wall Mounting

**Note:** Mounting screw locations should be marked on the wall. Do not insert a drill bit through the mounting holes of the back plate when drilling holes.

1. Disconnect the power cord from the power source.
2. Unlock and remove the cover.
3. Locate the teardrop mounting hole and the two  $\frac{1}{4}$ " mounting holes in the back plate.

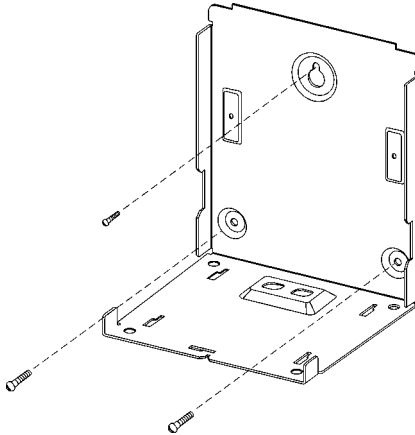

4. Approximate the final location of the clock. Insert one #10 wood screw or equivalent into the wall 1-1/2" (38 mm) from the top center location of the clock.
5. Hang the clock on the screw using the teardrop mounting hole.
6. Secure the clock to the wall by inserting screws through the bottom two mounting holes.
7. Reconnect the power cord to the power source.
8. Re-install the cover and secure.

---

## Make a Test Print

1. Make sure that there is power to the TCX-21 (Refer to Page 3).
2. Insert a piece of paper, or time card into the TCX-21. The clock will automatically print YEAR, MONTH, DATE and TIME with AM or PM.

'98 APR 10 AM 10:06

3. If the imprint is satisfactory, the TCX-21 is ready for use.
4. If you wish to change the time and/or print style on the TCX-21, enter the Program Mode to make changes to the print styles. The next page gives instructions on programming the TCX-21 to fit your needs.

## Adjusting the Margin

1. Unlock and remove the cover. Note – suggest unplugging the clock before performing margin adjustment.
2. Locate the Card Stopper Adjustment Screw on the right side of the clock, below the printer platen.
3. Position a piece of paper or time card as desired.
4. Loosen the screw to move the Card Stopper forward or back. Tighten the screw as needed. (See top illustration.) The print margin can be adjusted to a maximum of 7/8" (22 mm).

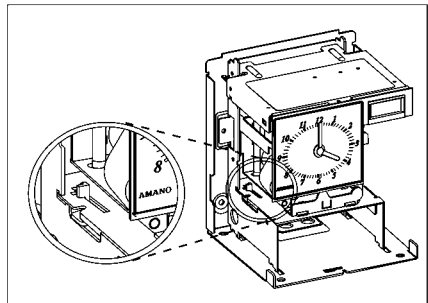
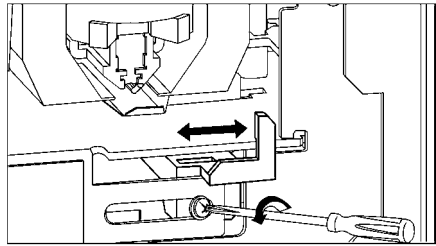

---

## Program Mode Guide

Unlock and remove the cover. Locate the **PROGRAM**, **CHANGE** and **ENTER** buttons on top of the clock.

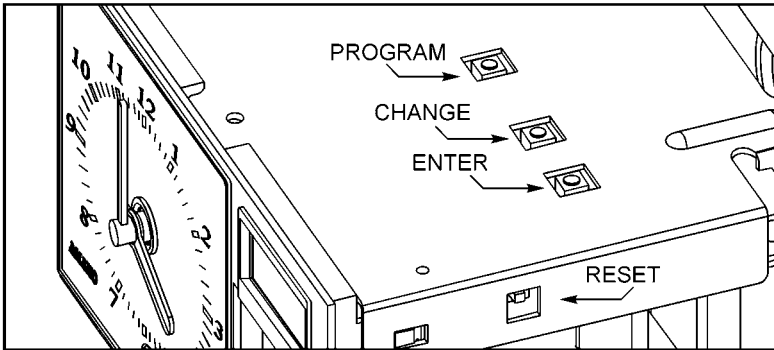

The **PROGRAM** button is used to enter and exit the Program Mode. Press the PROGRAM button at any time to exit the Program Mode. If a program step is in the process of being changed when this button is pushed, the new information will not be saved.

The **CHANGE** button is used to change the information on the display. When you are reviewing the main programming menu, use the CHANGE button to advance to the next programming step. When you are revising a programming step, use the CHANGE button to change the blinking information.

The **ENTER** button is used to accept the information shown on the display and save it in memory.

The **RESET** button is located on the right-side of the clock. Pressing this button will clear any jams or errors.

## Entering the Program Mode

1. Unlock and remove the cover.
2. Press and hold the PROGRAM button to access the Main Programming Menu. The Main Programming Menu consists of the Following:

Menu Code	Menu	Function
P1	dAtE	Sets the date
P2	Cloc	Sets the clock time
P3	dLSt	Disable/Enable Daylight Saving Time
P4	Prnt	Sets the print style using Quick Print Set-Up Codes
P5	Othr	Accesses Other Options Menu

- 
- When P1 dAtE flashes in the display, release the PROGRAM button. To move to the next menu item, press the CHANGE button.



**Note:** If no other button is pressed after five minutes, the clock will return to the Normal Mode and the clock hands will reset.

## Setting the Year, Month and Date

- When the display flashes P1 dAtE, press the ENTER button.
- Press the CHANGE button until the correct year appears, then press the ENTER button.
- Press the CHANGE button until the correct month appears, then press the ENTER button.
- Press the CHANGE button until the correct date appears, then press the ENTER button.
- When the display flashes the correct year, month and date, press the ENTER button.
- When the display flashes P1 dAtE, press the CHANGE button to move to Setting the Clock Time.

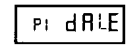
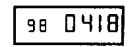
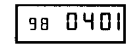
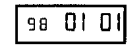
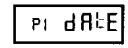

## Setting the Clock Time

**Note:** Use a 24 hour and 60 minute format when setting the time.  
For example, 2:00 PM = 14:00.

- Press the PROGRAM button for two seconds.
- Press the CHANGE button until the display flashes P2 CLoc, then press the ENTER button.
- Press the CHANGE button until the correct hour appears, then press the ENTER button.
- Press the CHANGE button until the correct minute appears, then press the ENTER button.
- When the display flashes the correct time, press the ENTER button.
- When the display flashes P2 CLoc, press the CHANGE button to move to the Daylight Saving Time On/Off Setting.

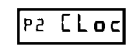
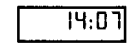
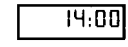
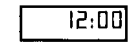



## Disabling/Enabling Daylight Saving Time (DST)

**Note:** When this setting is set to ON, the clock's time will automatically change for DST. When this setting is set to OFF, the clock's time will not change for DST. The dates to begin and end DST are set in the Other Options Menu (See page 8).

1. When the display flashes P3 dL St, press the ENTER button. P3 dL St
2. Press the CHANGE button to alternate between On and Off. on
3. When the display flashes the correct setting, press the ENTER button. OFF
4. When the display flashes P3 dL St, press the CHANGE button to move to the Quick Set-Up Code setting. P3 dL St

## The Quick Set-Up Code Setting

**Note:** If you do not wish to use one of the Quick Set-Up Code settings, you may set an alternate style on the following page.

1. When the display flashes P4 Prnt, press the ENTER button. P4 Prnt
2. The display will flash the current setting. Press the CHANGE button to scroll through each of the Quick Set-Up Code Settings. Pr-2

Code	Print Style	Print Direction
Pr-1	Day, 24Hr., 100th/Hr.	Right Side Print
Pr-2	Day, 12Hr., 60th/Hr.	Right Side Print
Pr-3	Month, Date, 24Hr., 100th/Hr.	Right Side Print
Pr-4	Month, Date, 12Hr., 60th/Hr.	Right Side Print
Pr-5	2 Digit Year, Month, Date, 12Hr., 60th/Hr.	Right Side Print
Pr-6	4 Digit Year, Month, Date, 12Hr., 60th/Hr.	Right Side Print
Pr-7	4 Digit Year, Month, Date, 24Hr., 60th/Hr.	Right Side Print

3. When the display flashes the correct setting, press the ENTER button. Pr-2
4. When the display flashes P4 Prnt, press the CHANGE button to move to the Other Options menu. P4 Prnt

## Accessing the Other Options Menu

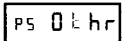
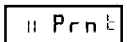
1. When the display flashes P5 Othr, press the ENTER button. 
2. The display will flash the first programming step in the Other Options sub-menu [11 Prnt]. Press the CHANGE button to advance through the menu selections. 

Menu Code	Menu	Function
I1	Prnt	Set Print Style using Symbol or Print Style Codes
I2	LAN9	Sets the Language of the print out
I3	Prdr	Sets the Print Direction (left or right hand)
I4	APrt	Disable, enable, or configure the Auto print option
I5	2Er0	Disable/enable Leading Zero in print out
I6	bdLt	Set the date that Daylight Saving Time begins
I7	EdLt	Set the date that Daylight Saving Time ends
I8	dIA9	Accesses the Diagnostic Routine

## Setting Up Alternate Print Styles

**Note:** If you do not wish to use one of the Quick Set-Up Code settings, you may select from the Alternate Print Style sub-menu.

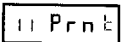
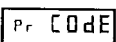
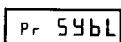
1. When the display flashes 11 Prnt, press the ENTER button. 
2. Press the CHANGE button to move from Code setting to Symbol setting. If you select Code, you must enter a Print Style Code from Table 1 on the next page. If you select Symbol, you can “build” a custom Print Style using Tables 2 and 3 on pages 11 and 12.   

3. When the display flashes the correct setting, press the ENTER button.

## Selecting a Print Code

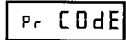
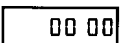
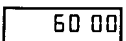
**Note:** Refer to Table 1 on the next page for Print Style Codes.

1. When the display flashes Pr COdE, press the ENTER button. 
2. Press the CHANGE button until the desired number appears in the first position. Press the ENTER button. 
3. Press the CHANGE button until the desired number appears in the second position. Press the ENTER button. 

4. Press the CHANGE button until the desired number appears in the third position. Press the ENTER button. 65 00
5. Press the CHANGE button until the desired number appears in the fourth position. Press the ENTER button. 65 70
6. When the display flashes all four correct numbers, press the ENTER button. 65 70
7. When the display flashes 11 Prnt, press the CHANGE button to move to the Language Setting. 11 Prnt

**Table 1: Print Style Codes for the Program Mode**

Code	Print Style	Print Direction
6510	DAY, 12H, 60th	Right Side Printing
6210	DAY, 24H, 10th	Right Side Printing
6810	DAY, 24H, 100th	Right Side Printing
6520	DATE, 12H, 60th	Right Side Printing
6620	DATE, 24H, 60th	Right Side Printing
6820	DATE, 24H, 100th	Right Side Printing
6540	DATE, MONTH, 12H, 60th	Right Side Printing
6640	DATE, MONTH, 24H, 60th	Right Side Printing
6840	DATE, MONTH, 24H, 100th	Right Side Printing
6680	DATE, MONTH, YEAR, 24H, 60th	Right Side Printing
6530	MONTH, DATE, 12H, 60th	Right Side Printing
6630	MONTH, DATE, 24H, 60th	Right Side Printing
6830	MONTH, DATE, 24H, 100th	Right Side Printing
6570	YEAR, MONTH, DATE, 12H, 60th	Right Side Printing
6071	YEAR, MONTH, DATE, RCV'D	Right Side Printing
6072	YEAR, MONTH, DATE, SENT	Right Side Printing
6073	YEAR, MONTH, DATE, FAX'D	Right Side Printing
6074	YEAR, MONTH, DATE, VOID	Right Side Printing
6075	YEAR, MONTH, DATE, PAID	Right Side Printing
6076	YEAR, MONTH, DATE, CFM'D	Right Side Printing
6077	YEAR, MONTH, DATE, APR'D	Right Side Printing
6078	YEAR, MONTH, DATE, CMPL'D	Right Side Printing
6079	YEAR, MONTH, DATE, ORIGN	Right Side Printing
6070	YEAR, MONTH, DATE, FILE	Right Side Printing
5510	DAY, 12H, 60th	Left Side Printing
5210	DAY, 24H, 10th	Left Side Printing
5810	DAY, 24H, 100th	Left Side Printing
5520	DATE, 12H, 60th	Left Side Printing
5620	DATE, 24H, 60th	Left Side Printing
5820	DATE, 24H, 100th	Left Side Printing
5540	DATE, MONTH, 12H, 60th	Left Side Printing
5640	DATE, MONTH, 24H, 60th	Left Side Printing
5840	DATE, MONTH, 24H, 100th	Left Side Printing
5680	DATE, MONTH, YEAR, 24H, 60th	Left Side Printing
5530	MONTH, DATE, 12H, 60th	Left Side Printing
5630	MONTH, DATE, 24H, 60th	Left Side Printing

Code	Print Style	Print Direction
5830	MONTH, DATE, 24H, 100th	Left Side Printing
5570	YEAR, MONTH, DATE, 12H, 60th	Left Side Printing
5071	YEAR, MONTH, DATE, RCV'D	Left Side Printing
5072	YEAR, MONTH, DATE, SENT	Left Side Printing
5073	YEAR, MONTH, DATE, FAX'D	Left Side Printing
5074	YEAR, MONTH, DATE, VOID	Left Side Printing
5075	YEAR, MONTH, DATE, PAID	Left Side Printing
5076	YEAR, MONTH, DATE, CFM'D	Left Side Printing
5077	YEAR, MONTH, DATE, APR'D	Left Side Printing
5078	YEAR, MONTH, DATE, CMPL'D	Left Side Printing
5079	YEAR, MONTH, DATE, ORIGN	Left Side Printing
5070	YEAR, MONTH, DATE, FILE	Left Side Printing

If you cannot locate the desired print style from the above list, refer to the instructions on the next page for programming the print style using symbols.

## Customizing a Print Style Using Character Symbols

**Note:** The maximum displacement (print length) of the print head is 152 dots or 1.4" (35 mm). When viewed on the LCD display, this value becomes a percentage, where the maximum allowable value is 99%. To determine if your desired symbol will print, add the lengths of each character used from the table. The total should be less than 150 dots or 99%. Please refer to Tables 2 and 3 representing the print styles, number of dots, or line lengths.

- When the display flashes Pr SYbL, press the ENTER button.
- Press the CHANGE button until the character symbol you want to print appears, then press the ENTER button.
- A 1 symbol will appear in the display to designate the first Symbol Code has been assigned.
- Continue to assign codes until you have finished.
- Press the CHANGE button until the En code flashes, then press the ENTER button.
- When the display flashes II Prnt, press the CHANGE button to move to the Language Setting.

## Table 2: Custom Print Style Samples

Print Style	Example	Code to Enter	Length
DAY,12Hr,60th/Hr	FRI PM 1:45	dAY SPCE 1260th	82
DAY,24Hr,60th/Hr	FRI 13:45	dAY SPCE 2460th	68
DAY,24Hr,10th/Hr	FRI 13.7	dAY SPCE 2410th	58
DAY,24Hr,100th/Hr	FRI 13.75	dAY SPCE 24100th	68
DATE,12Hr,60th/Hr	13 PM 1:45	dAtE SPCE 1260th	82
DATE,24Hr,60th/Hr	13 13:45	dAtE SPCE 2460th	68
DATE,24Hr,10th/Hr	13 13.7	dAtE SPCE 2410th	58
DATE,24Hr,100th/Hr	13 13.75	dAtE SPCE 24100th	68
MONTH,DATE,12Hr,60th/Hr	APR13 PM 1:45	month SPCE dAtE SPCE 1260th	115
MONTH,DATE,24Hr,60th/Hr	APR13 13:45	month SPCE dAtE SPCE 2460th	101
MONTH,DATE,24Hr,10th/Hr	APR13 13.7	month SPCE dAtE SPCE 2410th	91
MONTH,DATE,24Hr,100th/Hr	APR13 13.75	month SPCE dAtE SPCE 24100th	101
YEAR,MONTH,DATE,12Hr,60th/Hr	95 APR13 PM 1:45	YEAr SPCE month SPCE dAtE SPCE 1260th	143
YEAR,MONTH,DATE,24Hr,60th/Hr	95 APR13 13:45	YEAr SPCE month SPCE dAtE SPCE 2460th	129
YEAR,MONTH,DATE,24Hr,10th/Hr	95 APR13 13.7	YEAr SPCE month SPCE dAtE SPCE 2410th	119
YEAR,MONTH,DATE,24Hr,100th/Hr	95 APR13 13.75	YEAr SPCE month SPCE dAtE SPCE 24100th	129
YEAR,MONTH,DATE,SYMBOL1	95 APR13 RCV'D	YEAr SPCE month SPCE dAtE SPCE SY-1	127
YEAR,MONTH,DATE,SYMBOL2	95 APR13 SENT	YEAr SPCE month SPCE dAtE SPCE SY-2	124
YEAR,MONTH,DATE,SYMBOL3	95 APR13 FAX'D	YEAr SPCE month SPCE dAtE SPCE SY-3	127
YEAR,MONTH,DATE,SYMBOL4	95 APR13 PAID	YEAr SPCE month SPCE dAtE SPCE SY-4	124

### Table 3: Symbol Codes and Lengths

Code	Character	Length
2dYEA <sub>r</sub>	2 Digit Year	25=16.45%
nnonh	Month	30=19.74%
dAtE	Date	20=13.16%
dAY	Day	20=13.16%
JLAN	Julian Date	30=19.74%
12 10 <sup>th</sup>	12 Hr & 10 <sup>th</sup> /Hr	49=32.24%
12 20 <sup>th</sup>	12 Hr & 20 <sup>th</sup> /Hr	59=38.82%
12 60 <sup>th</sup>	12 Hr & 60 <sup>th</sup> /Hr	59=38.82%
12 100 <sup>th</sup>	12 Hr & 100 <sup>th</sup> /Hr	59=38.82%
24 10 <sup>th</sup>	24 Hr & 10 <sup>th</sup> /Hr	35=23.03%
24 20 <sup>th</sup>	24 Hr & 20 <sup>th</sup> /Hr	45=29.61%
24 60 <sup>th</sup>	24 Hr & 60 <sup>th</sup> /Hr	45=29.61%
24 100 <sup>th</sup>	24 Hr & 100 <sup>th</sup> /Hr	5=29.61%
SLSh	Slash ( / )	10=6.58%
dASh	Dash ( - )	07=4.61%
SPCE	Space ( )	03=1.97%
4dYEA <sub>r</sub>	4 Digit Year	28=14.00%
SY-1	RCV'D	43=28.29%
SY-2	SENT	40=26.32%
SY-3	FAX'D	43=28.29%
SY-4	VOID	40=26.32%
SY-5	PAID	40=26.32%
SY-6C	FM'D	43=28.29%
SY-7	APR'D	43=28.29%
SY-8	CMPL'D	53=34.87%
SY-9	ORIGN	50=32.89%
SY-10	FILE	40=26.32%
En	End of File	-
Ad	Add a Character	-
dL	Delete a Character	-

## Setting the Language

- When the display flashes I2 LAn9, press the ENTER button. I2 LAn9
- Press the CHANGE button until the correct language appears, then press the ENTER button. L1 En9
- When the display flashes I2 LAn9, press the CHANGE button to move to the Print Direction. Please refer to the table below for Language selections. I2 LAn9

English	Spanish	French	Portuguese
L1 En9	L2 SPn	L3 Frn	L4 Pt9

---

## Setting the Print Direction

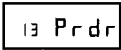
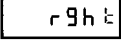
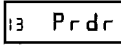
1. When the display flashes I3 Prdr, press the ENTER button. 
2. Press the CHANGE button until the correct direction appears, r9ht for Right Side Printing, or LEfT for Left Side Printing, then press the ENTER button. 
3. When the display flashes I3 Prdr, press the CHANGE button to move to the Auto Print Setting. 

## Setting the Auto Print

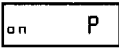
1. When the display flashes I4 APrt, press the ENTER button. 
2. Press the CHANGE button until the correct printing mode appears, then press the ENTER button. 

**Auto Print** (on P:): Will automatically print a single print when media is inserted.

**Manual Print** (OFF): Requires you to use the PRINT button when printing.

**Precision Print** (on P:5): Enables you to print multiple or consecutive prints when holding down the PRINT button.

3. When the display flashes I4 APrt, press the CHANGE button to move to the Leading Zero Setting. 

## Setting the Leading Zero On or Off

**Note:** The Leading Zero appears on the print out before single digit times and dates (For example DEC. 06, 08:00)

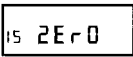
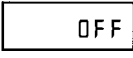
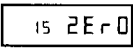
1. When the display flashes I5 2Er0, press the ENTER button. 
2. When the display flashes OFF or on, press the CHANGE button to toggle between off and on. Press the ENTER button to select. 
3. When the display flashes I5 2Er0, press the CHANGE button to move to the Begin Daylight Saving Time setting. 

---

## Setting Begin Daylight Saving Time

**Note:** The government standard for DST is subject to change. Your clock is factory-set for correct DST based upon when it was manufactured, but any revision to DST begin or end dates may require updating the system-set DST calendar.

The steps below change the begin date for DST. DST is enabled and disabled in the Main Programming Menu. Updating the begin date for DST needs to be done just one time\*, since the clock's rolling calendar function will auto-calculate the begin date for each year thereafter. To change the end date for DST, refer to the next section.

1. When the display flashes 16 bdLt, press the ENTER button.

16 bdLt

2. Press the CHANGE button until the correct year appears, then press the ENTER button.

90 0401

3. Press the CHANGE button until the correct month appears, then press the ENTER button.

98 0401

4. Press the CHANGE button until the correct date appears, then press the ENTER button.

98 0401

5. When the display flashes the correct year, month and date, press the ENTER button.

98 0402

6. When the display flashes 16 bdLt, press the CHANGE button to move to the End Daylight Saving Time Setting (17 EdLt will display).

16 bdLt

## Setting End Daylight Saving Time

**Note:** The government standard for DST is subject to change. Your clock is factory-set for correct DST based upon when it was manufactured, but any revision to DST begin or end dates may require updating the system-set DST calendar.

The steps below change the end date for DST. DST is enabled and disabled in the Main Programming Menu. Updating the end date for DST needs to be done just one time\*, since the clock's rolling calendar function will auto-calculate the end date for each year thereafter. To change the begin date for DST, refer to the previous section.

1. When the display flashes 17 EdLt, press the ENTER button.

17 EdLt

2. Press the CHANGE button until the correct year appears, then press the ENTER button.

90 1028

3. Press the CHANGE button until the correct month appears, then press the ENTER button.

98 1028



4. Press the CHANGE button until the correct date appears, then press the ENTER button. 98 1028
5. When the display flashes the correct year, month and date, press the ENTER button. 98 1029
6. When the display flashes 17 EdLt, press the CHANGE button to move to the Diagnostics Mode (see Exit Program Mode to end). 17 EdLt

## The Diagnostic Routine

The Diagnostic Routine checks the LCD segments, the number of prints, and clears the memory (Print Style, Language, Leading Zero Suppress, Clock and Calendar, Right/Left Print, and Daylight Saving Time features).

1. When the display flashes I8 dIa9, press the ENTER button. The Diagnostic Routine consists of the following: I8 dIa9

Menu Code	Menu	Function
d1	LCd	Tests the segments of the LCD
d2	nPrt	Displays total number of print outs
d3	CLr	Clears memory and restores default settings

2. When the display flashes d1 LCd (LCD segments check), press the ENTER button. d1 LCd
3. When all of the LCD segments are turned on, press the ENTER button to advance to the next step.
4. When the display flashes d2 nPrt (total number of prints), press the ENTER button. d2 nPrt
5. The number of prints counted will be displayed. Press the ENTER, then CHANGE button to advance to the next step. 00
6. When the display flashes d3 CLr (memory clear), press the ENTER button. d3 CLr
7. To clear the memory and reset the defaults, press the CHANGE button until the 3 appears, then press the ENTER button. Press the CHANGE button until the 2 appears, then press the ENTER button. 30
8. When the display flashes 32, press the ENTER button. 32

---

## Exit Program Mode

Press the PROGRAM button and the display will show the current date. The clock hands will reset to the current time.

**Note:** The TCX-21 uses a Lithium battery to maintain the user settings in case of a power failure. If a power failure occurs and the Lithium battery is dead, the time clock settings may revert to default settings (i.e., DST Begin and End dates may change).

## Replacing the Ribbon

### To Remove:

1. Remove the cover.
2. Pull the two white release tabs upward and remove the ribbon cassette.

### To Insert:

1. If the print mechanism is down and a piece of paper cannot be inserted, press the RESET button to move the carriage up. This will make the ribbon installation easier.
2. Insert the ribbon cassette. **Be sure to mount the ribbon between the printer head and ribbon guide as arrows illustrate.**
3. Turn the knob on the cassette clockwise one turn to take up any slack in the ribbon.
4. Replace the cover and check the print quality to confirm that you have installed the ribbon correctly.

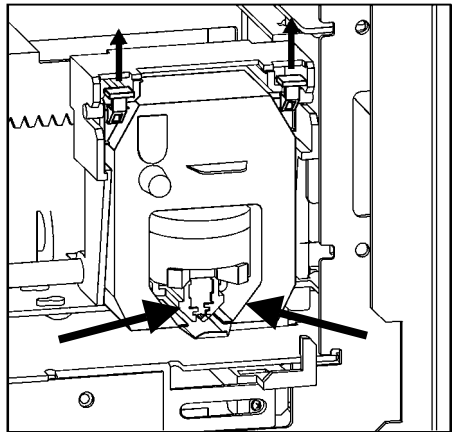

---

## Error Messages

Error Code	Cause
E1 Prt	Home sensor, motor carriage stuck
E2 Prt	Time sensor, carriage stuck
E3 Prt	Home sensor
E4 Prt	Carriage stuck
Er Pr t	General print error
dLt	Daylight Saving Time Program

For error messages E1 through E4, turn off the power before checking to see that the carriage is not stuck or jammed. Also, check to see that the ribbon cables are in good condition. After clearing any jams, restore the power and press the RESET button. Contact your Amano Cincinnati representative for assistance.

The dLt error message signifies that an attempt was made to get into the Program mode during the Daylight Saving changeover one-hour lockout. Wait one hour and you will be able to program the clock.



TO PLACE AN ORDER CALL: 866-487-4751  
OR VISIT: [WWW.TIMECLOCKEXPERTS.COM](http://WWW.TIMECLOCKEXPERTS.COM)

# **AMANO®**

*Corporate Headquarters*  
*140 Harrison Avenue, Roseland, NJ 07068-1239*  
*(800) 526-2559*

***[www.amano.com](http://www.amano.com)***