



TIMETRAX™ Sync
7000/7000BDL110

Master Clock Controller

User Guide

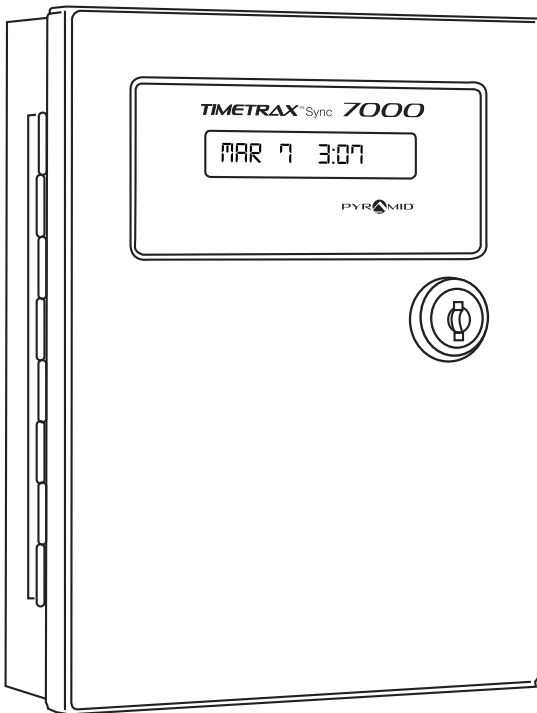

TABLE OF CONTENTS

TABLE OF CONTENTS 1

PRODUCT OVERVIEW 2

FEATURES..... 3

CONTENTS..... 4

WALL MOUNTING 5

INSTALLATION 6

PROGRAMMING 7-8

CLOCK CONNECTION 9-12

BELL CONNECTION 13-14

BELL SCHEDULE..... 15

SPECIFICATIONS 16-17

ACCESSORIES..... 18

WARRANTY & TECHNICAL SUPPORT 19

OVERVIEW

Thank you for choosing a TimeTrax Sync™ 7000/7000BDL110 Master Clock System. The TimeTrax Sync™ 7000/7000BDL110 synchronizes up to 200 TimeTrax Sync™ Analog Clocks (part #5200) and/or Digital Clocks (part# DIG4B, DIG6B) The system can provide power to eight TimeTrax Sync™ Analog Clocks (part #5200) using RJ45 connector. Digital Clocks need to have their own 100-240V AC 50/60Hz power supplied.

The TimeTrax Sync™ 7000 integrates with 24V DC bells or horns and is able to operate a bell/horn schedule up to 300 events per 24 hours.

The TimeTrax Sync™ 7000BDL110 includes a Relay SPDT contact for bells and horns. The contact rate is 10amps @ 125V AC or 7A @30V DC. Please refer to page 17 for a complete list of bell and horns.

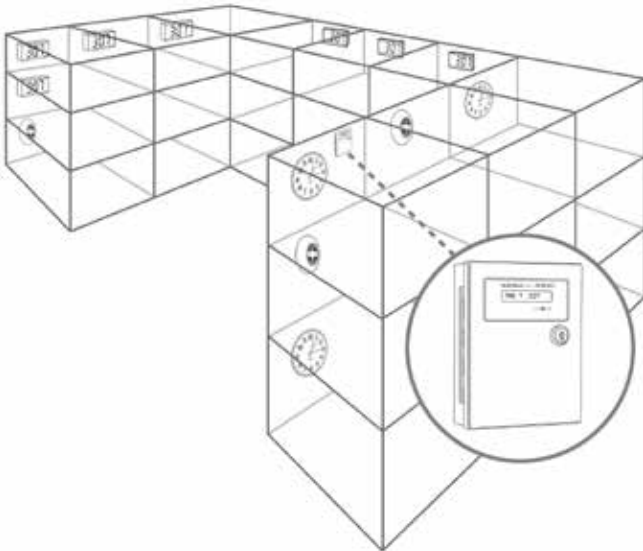
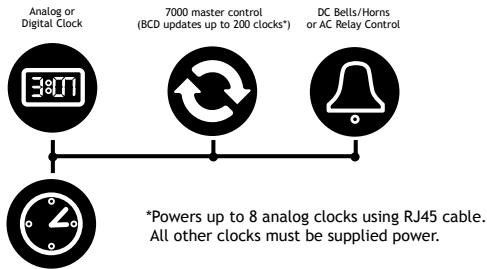

7000/7000BDL110 MASTER CLOCK CONTROLLER : FEATURES

	7000	7000BDL110
Synchronization Capacity	200 TimeTrax Sync™ Analog and/or Digital Clocks	200 TimeTrax Sync™ Analog and/or Digital Clocks
Synchronization Distance	Up to 300 feet	Up to 300 feet
Analog Clock Power	Up to 8 Analog Clocks (part #5200) using RJ45	Up to 8 Analog Clocks (part #5200) using RJ45
Bell/Horn Interface	24V DC Bells and Horns	110V AC Bells and Horns
Bell Scheduling	Up to 300 Events	Up to 300 Events
Bell & Horn Power	Up to 35 bells (part #41361 & 41392) or 800 milliamps (mA) per event Up to 20 horns (part #41362) or 800 milliamps (mA) per event	Contact SPDT 10amps total @ 125V AC, 7A @ 250V AC or 7A @ 30V DC Bells #41397R & #41398G Horns #41363
Display	Date & Time (AM/PM or Military)	Date & Time (AM/PM or Military)
Automatic Time Adjustment	Short months, Leap Year & Daylight Saving Time	Short months, Leap Year & Daylight Saving Time
Tamper-Proof Security Lock	Yes	Yes
Warranty	1-Year manufacturer's limited warranty	1-Year manufacturer's limited warranty

CONTENTS

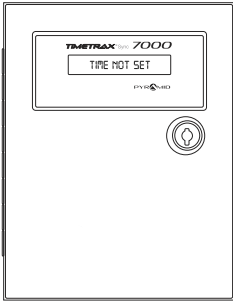

TimeTrax Sync™ 7000
Master Clock Controller

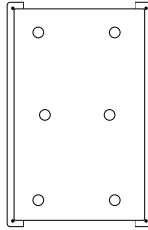

Relay
(7000BDL110 ONLY)

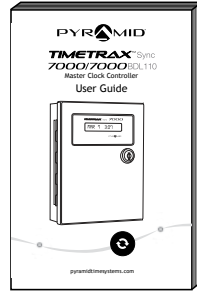

7000/7000BDL110
User Guide

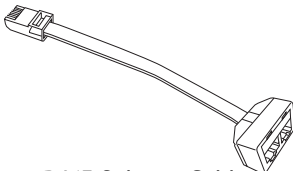

RJ45 Splitter Cable

Power Adapter

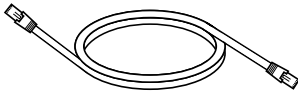
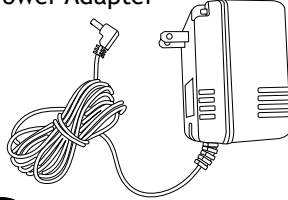

RJ45 50' Cable



Security
Keys (2)

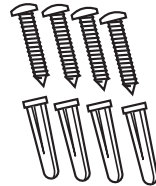

Mounting Screws (4)
Wall Anchors (4)

WALL MOUNTING

- ① Use key to unlock and open front cover.

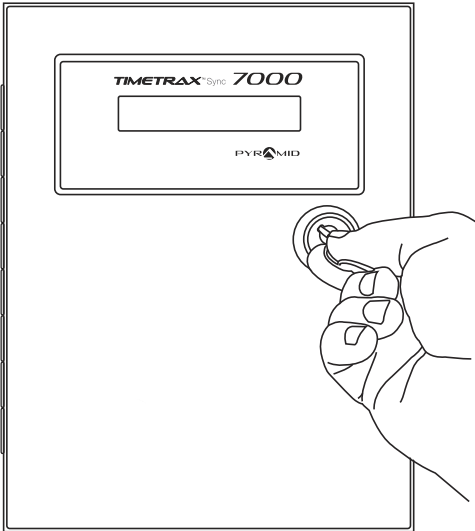

- ② Select a location for mounting. Power outlet should be within 5 feet of mounting location.
- ③ With door, open, hold the case in desired location and mark holes for drilling. Drill holes for mounting.
- ④ Install screws in wall, leaving approximately 3/16 inch of screws exposed. For sheet rock walls, use plastic anchors.
- ⑤ Hang TimeTrax Sync™ 7000 on wall, aligning keyholes on the rear with screw heads. Press downward on case until it lowers onto screws.

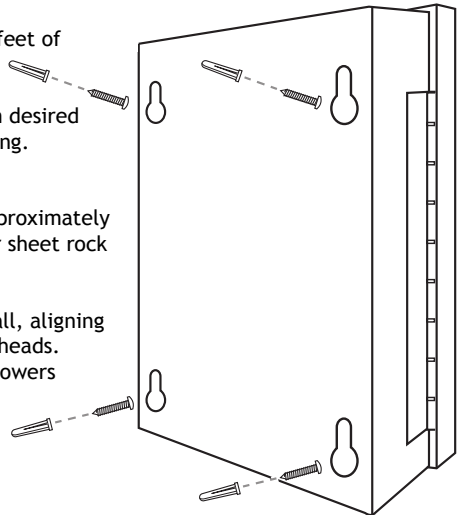

INSTALLATION / 7000

- ① Route the power supply through cable channel located on right side or bottom of the 7000 case. Connect power supply into power port labeled POWER.
- ② Plug power supply into standard electrical wall outlet.

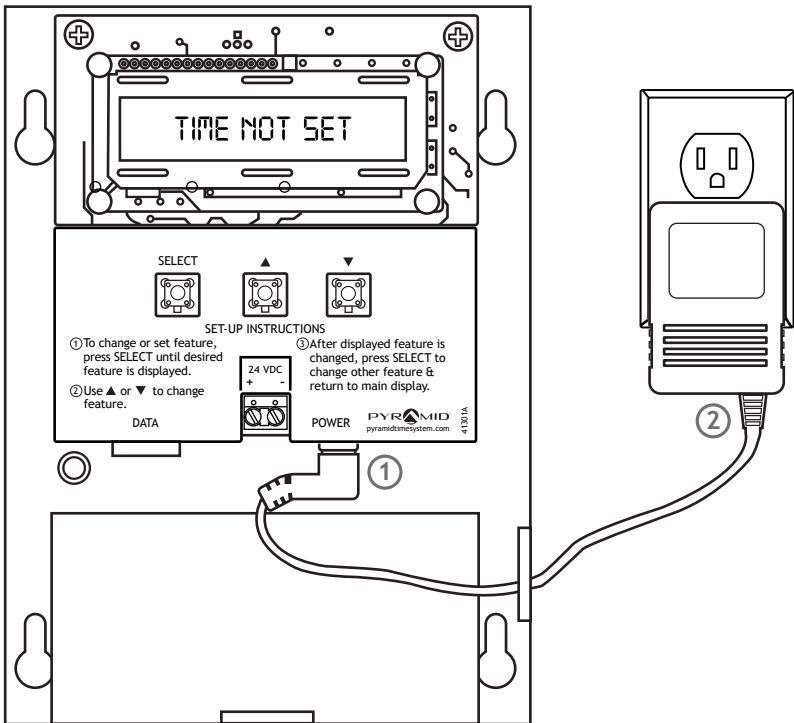

PROGRAMMING

The diagram illustrates the programming interface. At the top, three buttons are shown: a square button labeled 'SELECT', a square button with an upward-pointing triangle, and a square button with a downward-pointing triangle. Below these buttons is the text 'SET-UP INSTRUCTIONS'. To the left of the instructions are the labels 'DATA' and 'POWER'. In the center, a display shows '24 VDC' with a '+' sign on the left and a '-' sign on the right. Below the display is a small icon of a power switch. To the right of the display is the 'PYRAMID' logo and the website 'pyramidtimesystem.com'. On the far right, the number '41301A' is printed vertically.

SELECT

▲ ▼

SET-UP INSTRUCTIONS

① To change or set feature, press SELECT until desired feature is displayed.

② Use ▲ or ▼ to change feature.

③ After displayed feature is changed, press SELECT to change other feature & return to main display.

DATA

24 VDC
+ -

POWER PYRAMID
pyramidtimesystem.com 41301A

- ① Locate programming buttons labeled SELECT, (▲) (UP) & (▼) (DOWN).
- ② Press SELECT until desired feature is displayed (see chart on next page).
- ③ Press (▲) (UP) or (▼) (DOWN) to scroll through feature options.
- ④ Press SELECT to save option setting and move onto next feature.

7000 MASTER CLOCK CONTROLLER : PROGRAMMING

FEATURE (SELECT)	DISPLAY	DEFAULT SETTING	OPTIONS (SCROLL ▲▼)
Schedule Bells	SET EVENT * NO	NO	NO: No event(s) scheduled. YES: Schedule event(s) SET EVENT #1-300 See instruction on p.15.
Date Format	DATE FMT = USA	USA	Use the UP or DOWN key to select USA or EURO (European) display format for time.
Set Year	SET YEAR = 2001	2001	Use the UP or DOWN key to set the current year.
Set Month	SET MONTH = JAN	JAN	Use the UP or DOWN key to set the current month.
Set Day	SET DAY = 1	1	Use the UP or DOWN key to set the current day of month.
Set Daylight Saving Time (DST) Rule	DAYL'T SAV = USA	USA	USA: USA DST: Begins 2nd SUN of MAR, Ends 1st SUN of NOV EURO: European DST: Begins Last SUN of MAR, Ends Last Sun of OCT OTHER: Set a custom DST Rule Choose from LINE or CRYSTAL time base. OFF: No adjustment for DST.
Set Format	DSPLY FMT =	AM/PM	AM/PM: 12 Hour MIL: Military, 24 Hour
Set Hour	SET HOUR = 12PM	12AM	Use the UP or DOWN key to set the current hour of day.
Set Minutes	SET MINUTES = 00	00	Use the UP or DOWN key to set the current minute.

CLOCK CONNECTION

- 1 Using RJ45 BCD Cable, connect one end of the cable to the 7000 port labeled DATA and route cable through cable channel located on the right side or bottom of 7000 case.
- 2 Connect the other end of the RJ45 cable to port located on back of Analog or Digital clock.
- 3 Mount and install wall clocks according to instructions included with clock.

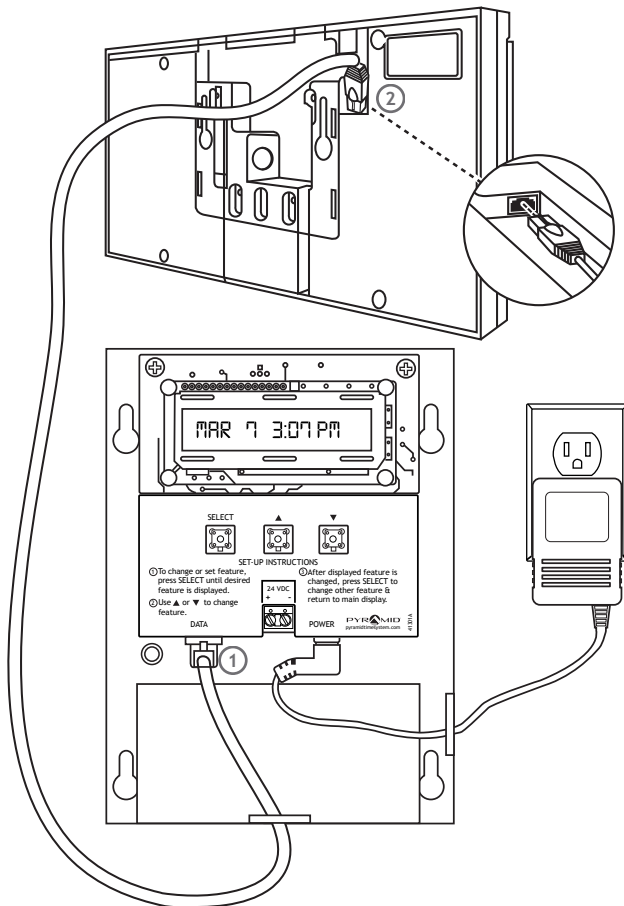

CLOCK CONNECTION

- 1 Use RJ45 Splitter Cable (part # 41270) to add more clocks. Up to 200 clocks may be added to the system, however clocks should be located within 300 feet of 7000 unit to receive the synchronization time data (BCD signal).

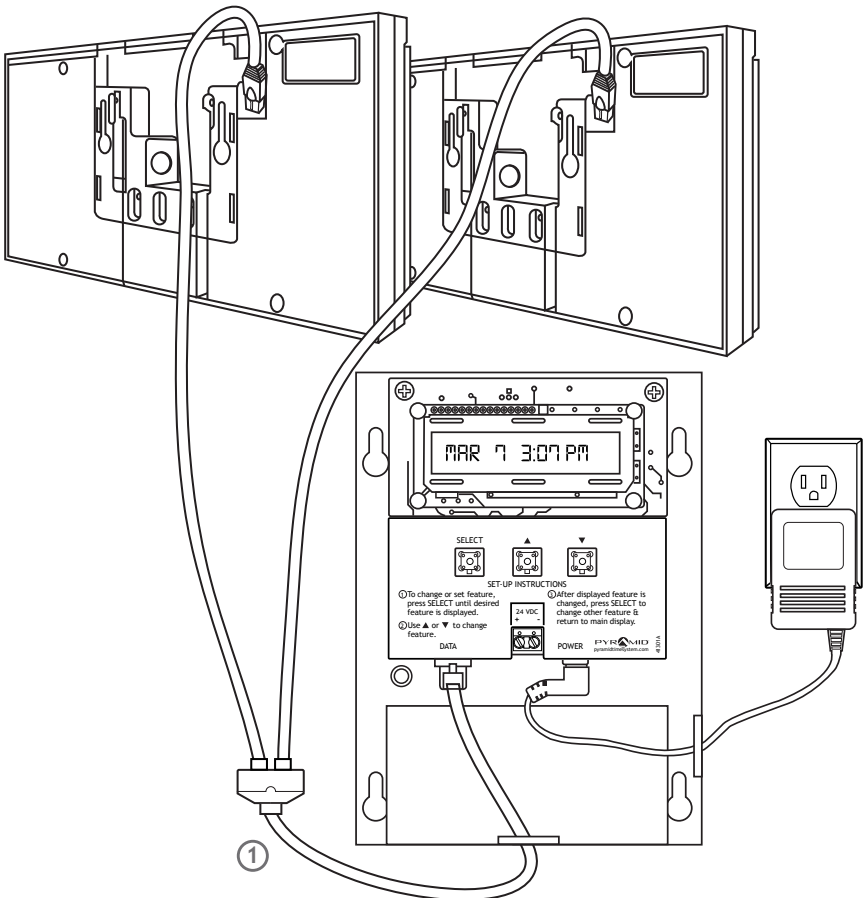

CLOCK CONNECTION (BCD)

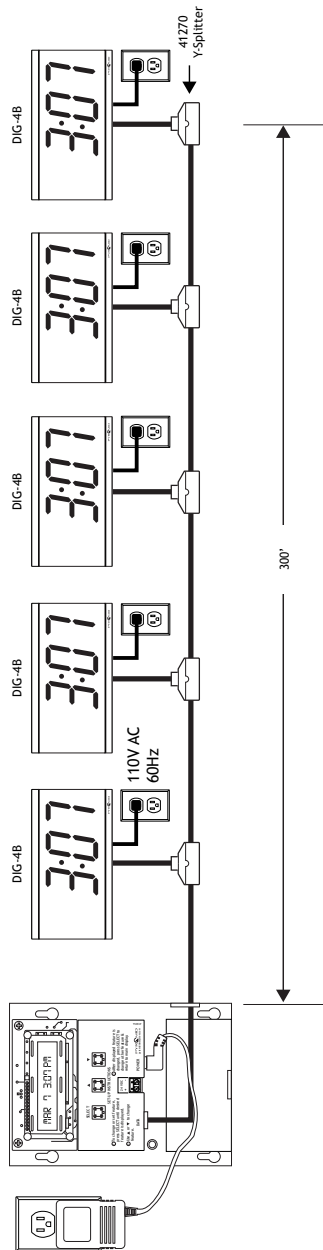

CLOCK CONNECTION (BCD & POWER)

7000 Master Clock powers up to 8 clocks using RJ45 cable. For more than 8 clocks, use 5300 (up to 8 clocks) or power up clocks individually from 110V AC 60Hz sources using a licensed electrician.

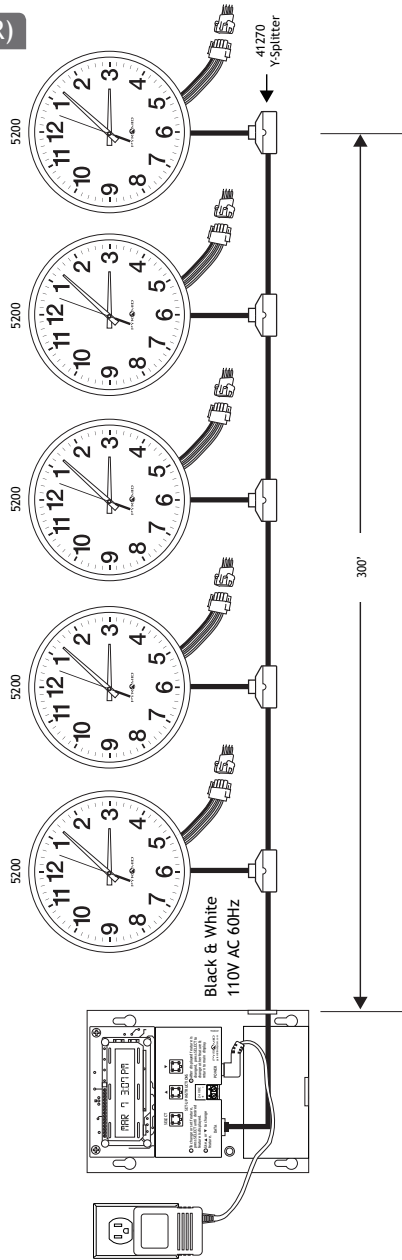

BELL CONNECTION & SCHEDULE

110V AC BELL CONNECTION WITH 7000BDL110

CAUTION: 110V MUST BE INSTALLED BY A LICENSED ELECTRICIAN. Please refer to diagram.

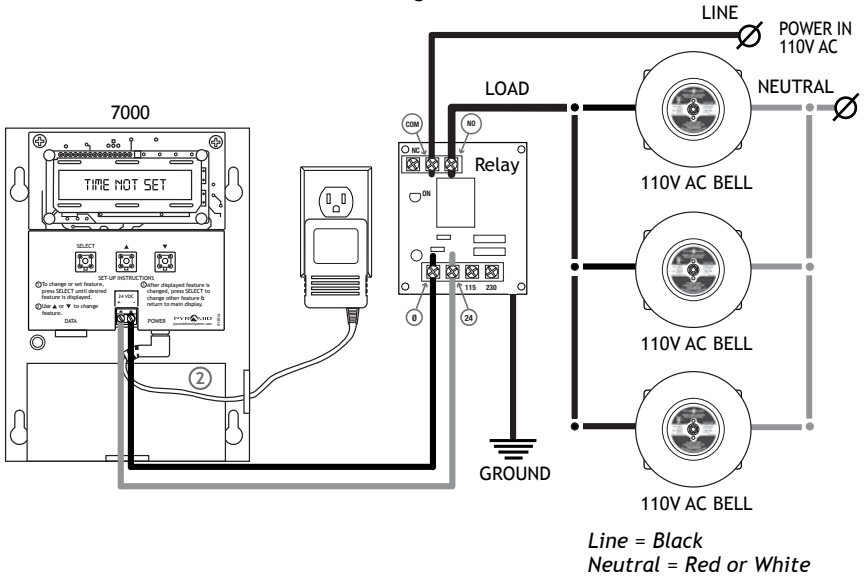

24V DC BELL CONNECTION

The 7000 will provide power to 24V DC bells and/or horns, up to 800 milliamps (mA) per event.

- ① Wire 24V DC Bells and/or Horns to the 7000 terminal labeled 24 VDC using 16-20 gauge wire (sold separately)
- ② Route the bell wire through the cable channel located on right side or bottom of 7000 case. A total of 35 bells (part #41361, 41392) or 20 Horns (part #41362) can be connected to the circuit.
- ③ Use the following table to set a bell/horn schedule. Program up to 300 bell/horn events per 24 hours.

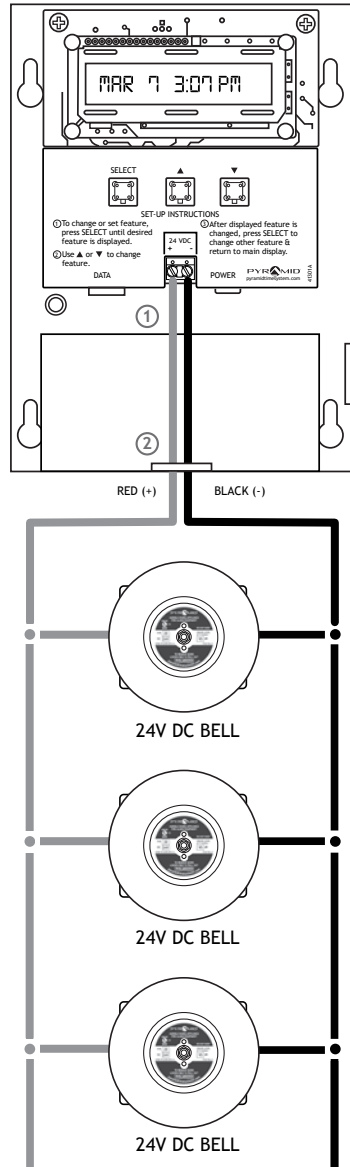

SET EVENT

MENU : SET EVENT ▲▼

SCHEDULE AN EVENT (e.g. Sound Bells/Horns)

FEATURE (SELECT)	DISPLAY	DEFAULT SETTING	OPTIONS (SCROLL ▲▼)
Set Event Schedule	SET EVENT *	NO	Scroll ▲(UP) or ▼(DOWN) to schedule event
Assign the Event a Number (1-300)	SET EVENT * I	1	SET EVENT (e.g.1, 2, 3 ... 300)
Set the Event's Duration	EVENT *	OFF	OFF, .5 SEC, 1-15 SEC (determines length of time buzzer/bell/horn sounds)
Set the Event's Hour	EVENT * HR =	12 AM (AM/PM) 00 (MIL)	EVENT HOUR +/- One Hour 12 HR: 12AM-11PM 24 HR: 00-23
Set the Event's Minute	EVENT * MIN =	00	EVENT MINUTE +/- One Minute (e.g. 00, 17, 59)
Set the Event's Day	EVENT * DAY =	ALL	Monday thru Friday Event: M-F One day event: SUN, MON, TUE, WED, THU, FRI, SAT All week event, SUN-SAT: ALL

SPECIFICATIONS

7000 SPECIFICATIONS

Part#	7000/7000BDL110
Time Set	Manual
Power Output	1. 24V DC 800mA (bells, horns, relay) 2. 24V DC using RJ45 (powers up to 8 analog clocks, #5200, #5217N)
Power	Power Adaptor 120V AC/18V AC, 1000mA
BCD Time Updates	Up to 200 clocks, using RJ45
Operating Temp	-30° F (-34.44° C) to 130° F (54.44° C)
Display	LCD, date & time
Housing	Textured powder coat surface metal
Color	Black
Mounting	Wall Mount
Warranty	1-Year manufacturer's limited warranty
Dimensions	5.5"W x 7.125"H x 1.75"D (13.9cm x 18.1cm x 4.4cm)
Weight	1.81lbs (.81kg)
Shipping Weight	4.451lbs (2.01kg)

BELL RELAY SPECIFICATIONS*

Contact Rating	10A @ 125V AC, 7A @ 250V AC (SPDT)
Color	Putty
Mounting	Wall Mount
Dimensions	3.125"W x 5.25"H x 2.625"D (7.93cm x 13.33cm x 6.66cm)
Weight	.75lbs (.34gr)
Shipping Weight	1lb (.045gr)

*Included with 7000BDL110.

SPECIFICATIONS

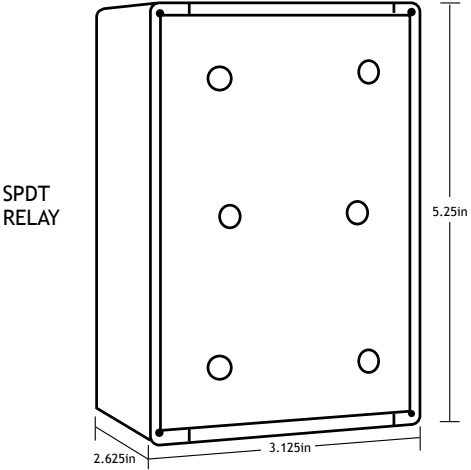
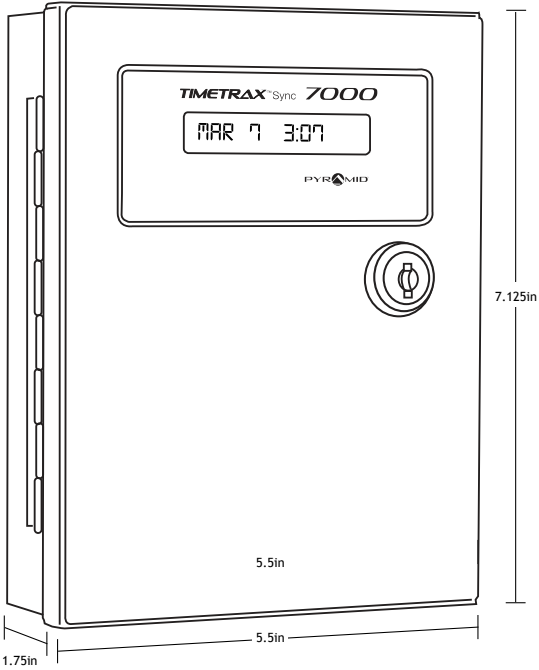

ACCESSORIES	
PART #	DESCRIPTION
DIG-4B	4" x 4-digit Red LED Independent Digital Clock
DIG-6B	4" x 6-digit Red LED Independent Digital Clock
41357G	4" x 4-digit Red LED Digital Clock
61357G	4" x 6-digit Red LED Digital Clock
5200	13" Analog Clock 12 Hour Face
5217N	17" Analog Clock 12 Hour Face
5300*	Single Bell Ringer
41200	Power Adaptor 120V AC/18V AC
41269	RJ45 BCD Cable, 50'
41314	RJ45 BCD Cable, 100'
41270	RJ45 Y-Splitter Cable
41361	6" 24V DC Bell
41392	8" 24V DC Bell
41362	24V DC Horn
41363	110V AC Horn (7000BDL110 ONLY)
41397R	6" 110V AC Bell, red (7000BDL110 ONLY)
41398G	8" 110V AC Bell, grey (7000BDL110 ONLY)
41449	Bell Wire, 100' Spool (2 Conductor 20 AWG 80°C, 300V)
41450	Bell Wire, 250' Spool (2 Conductor 18 AWG 80°C, 300V)

*Powers up to eight 5200 or 5217N Analog Clocks using RJ45.

WARRANTY

1-YEAR LIMITED WARRANTY

Pyramid warrants its Synchronized Clock Systems to the original user against defective material or workmanship for a period of 1 year from date of purchase.

The manufacturer's responsibility under this Warranty is limited to repair or replacement of defective part or parts. Pyramid reserves the right to determine whether parts failed because of defective material, workmanship, or other causes. Failure caused by accident, alteration, misuse or improper packaging of returned unit is not covered by this Warranty. Any repair to equipment other than by Pyramid voids the Warranty. Users in territories other than USA, Canada, South America & Australia should contact the Dealer from whom the unit was purchased. The rights under this Warranty are limited to original user and may not be transferred to subsequent users.

If Customer Support cannot troubleshoot your problem over the phone, we will replace your unit free of charge if it is within warranty period. Please contact Customer Support at **888.479.7264** between the hours of **8am-5pm EST** for details.

TECHNICAL SUPPORT

Should you need to speak live to one of our representatives, please call toll-free (US/Canada) at **888.479.7264** during regular business hours: **8am-5pm EST, M-F**.

SIMPLE : SMART[®]



CONTACT US:

For more information, visit pyramidthimesystems.com or call our technical support team at **888.479.7264** during regular business hours: **8am-5pm EST, Monday-Friday.**

Copyright © 2018 Pyramid Time Systems, LLC. All rights reserved.