

AMANO

PIX-25

Atomic Time Clock

Installation and Operation Guide





TO PLACE AN ORDER CALL: 866-487-4751
OR VISIT: WWW.TIMECLOCKEXPERTS.COM

Thank You....

For purchasing another fine product from
www.TimeClockExperts.com

**For safe and proper operation, please carefully read the manual
before using the time clock and save it for reference.**

Proprietary Notice

This document contains proprietary information and such information may not be reproduced in whole or part without the written permission from:

Amano Cincinnati, Inc.

140 Harrison Ave.,
Roseland, New Jersey 07068-1239

Amano Cincinnati, Inc. reserves the right to make equipment changes and improvements, which may not be reflected in this document. Portions of this document may have been updated to include the latest hardware or firmware version, if applicable.

To ensure safe use of this time recorder/stamp, be sure to thoroughly read this manual in its entirety before any attempt is made to operate the equipment. After you have finished reading this manual, be sure to store it in a safe place for future reference.

For more information about Amano's complete line of time products, visit our web site at:

WWW.TIMECLOCKEXPERTS.COM

Warranty Notice

Any claim for warranty, express or implied, due to the clocks failure to properly receive the radio signal because of interference, whatever may be the source of this interference, are hereby expressly excluded.

The PIX-25 has the atomic clock (radio-controlled clock) feature which displays the current time precisely by automatically receiving time code signals on long wave radio from the transmitting station. The unit receives the time code signal via its built-in antenna system.



















Note: This equipment has been tested and found to comply with the limits for a Class A digital device, pursuant to part 15 of the FCC Rules. These limits are designed to provide reasonable protection against harmful interference when the equipment is operated in a commercial environment. This equipment generates uses and can radiate radio frequency energy and, if not installed and used in accordance with the instruction manual, may cause harmful interference to radio communications. Operation of this equipment in a residential area is likely to cause harmful interference in which case the user will be required to correct the interference at his own expense.

Table of Contents

GUIDELINES FOR SAFE OPERATION	4
Remove the Cover & Packing Material	6
Setting the Time (P1)	7
Setting the Date [Month/Date/Year](P2)	7
Enabling or Disabling Daylight Saving Time (DST) (P3)	8
Changing the Print Style (P4) 12Hr (Standard) or 24Hr (Military) Default = Preset 1 (12hr)	8
Set Other (P5)	10
Set Print Language (P-51)	10
Set Print Direction (P-52)	11
Set Paper Detection (P-53)	12
Set Print Leading Zero (P-54)	13
Set Numbering (P-55)	13
Changing Begin Date for Daylight Saving Time (P-56)	14
Changing End Date for Daylight Saving Time (P-57)	15
Set Display Hour Format (P-58)	16
Customize	17
Code Program – Custom Printing (P61)	17
Setting Custom Print (Symbol Printing) (P62)	19
Diagnostics	22
Main Board Version (d1)	22
LCD Test (d2)	22
Show Number Printed (d3)	23
Clear Memory (d4)	23
Warning Message (d5)	24
Advanced Diagnostics (d6)	25
Acceptable Print Media	26
Atomic Clock Feature (Not available in HI and AK)	26
Ribbon Cartridge Replacement	27
Parts	28
Error Messages	29
PIX-25 Support	31
PIX-25 Cleaning	31
Resetting Clock After Extended Loss of Power	31
PIX-25 Power Modes	31
PIX-25 Time Display Modes	32
Wall Mounting	32
PIX-25 Programable Features Summary	34
Warranty Notice	35
Wall Mounting (Optional)	36
Operation	37
PIX-25 Views	37
PIX-25 View Description	38
Warranty Information	39
Specifications	40

GUIDELINES FOR SAFE OPERATION

To ensure safe operation, please carefully read the following warnings and cautions prior to using the PIX-25 Electronic time recorder/stamp.

 Warning	
	Do not disassemble the unit. There is a high voltage present inside, possibly leading to an electric shock.
	Do not modify the unit. Modifications may cause a fire and/or electric shock.
	If any anomaly occurs, for example, heat or smoke is generated or an odor is emitted, unplug the unit immediately and contact your dealer for servicing. There is a danger that further use may cause a fire or electric shock.
	Do not use any voltage of the power source other than designated. Do not share a single outlet with another plug. These may lead to fire or shock hazards.
	Do not damage, break, or modify the power cord. Do not put a heavy object on, pull, or forcefully bend the cord, either. These may damage the cord, possibly resulting in a fire or electric shock.
	If foreign matter should get in the unit (including a piece of metal, water, or liquid), disconnect the plug from the outlet immediately and contact your dealer for servicing. There is a danger that further use may cause a fire or electric shock.
	Do not plug or unplug the unit with a wet hand. You may get an electric shock.
 Caution	
	Do not place the unit on an uneven or tilted surface. This may result in injuries due to the unit dropping or falling off.
	Do not put a water-filled container or a metal object on top of the unit. If water is spilled or the metallic object slips inside, a fire or shock hazard may occur.
	Do not install the unit in a humid or dusty environment. It may cause a fire or electric shock.
	Do not place the unit near kitchen counter or humidifier. Oil, smoke, or steam generating from them may cause fire or shock hazards.
	Do not yank the power cord to disconnect from the outlet. Hold the plug with your hand to do so, or the cord may be damaged, possibly leading to a fire or electric shock.
	Remove the line cord plug from the outlet before transferring the unit, or it may damage the cord, possibly leading to a fire or electric shock.
	Be careful not to contact the print head, as you may get hurt or burned.
	Make sure to insert the power plug as far as it will go. Improper insertion of the plug may develop fire or shock hazards.
	Do not insert or drop any other time card than specified into the slot. Such misuse may cause a fire or electric shock.
	If the unit should be dropped or the case is broken, unplug the unit and contact your dealer for servicing. Further use may lead to a fire or shock hazard.

Relation to the Health and the Environment

The plastic currently used for the outer enclosure of this apparatus does not contain the halogen substance.

Cover Removal

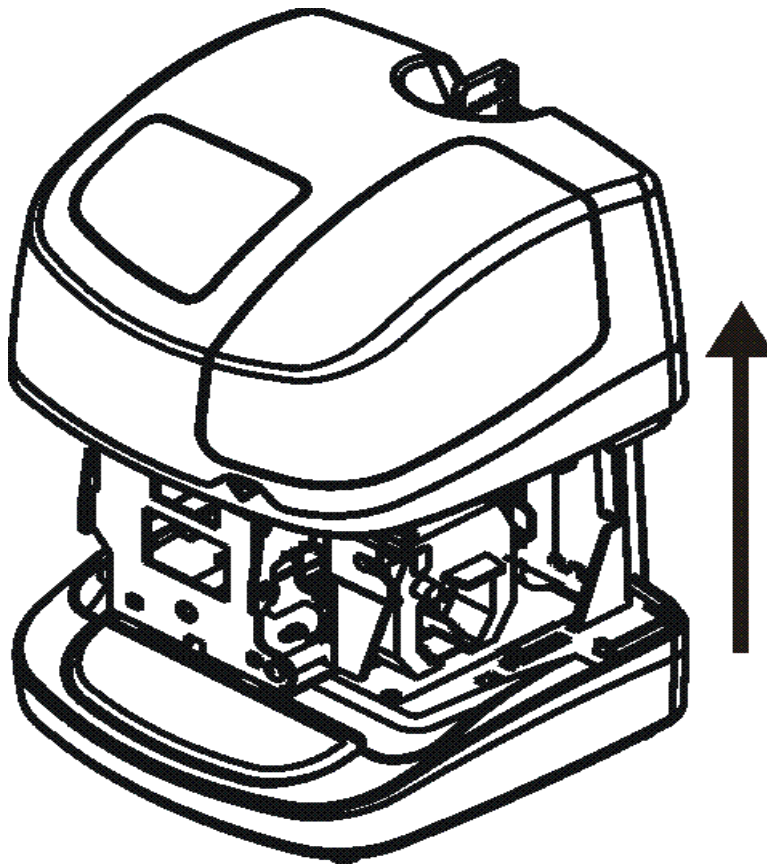

Remove the Cover & Packing Material

1. Insert the key provided into the keyhole on top of the clock, turn clockwise $\frac{1}{4}$ turn to unlock the cover and lift the cover to remove (see Figure on previous page).
2. Remove the cardboard spacer located above the ribbon cartridge by pulling straight out (see right-hand Figure).

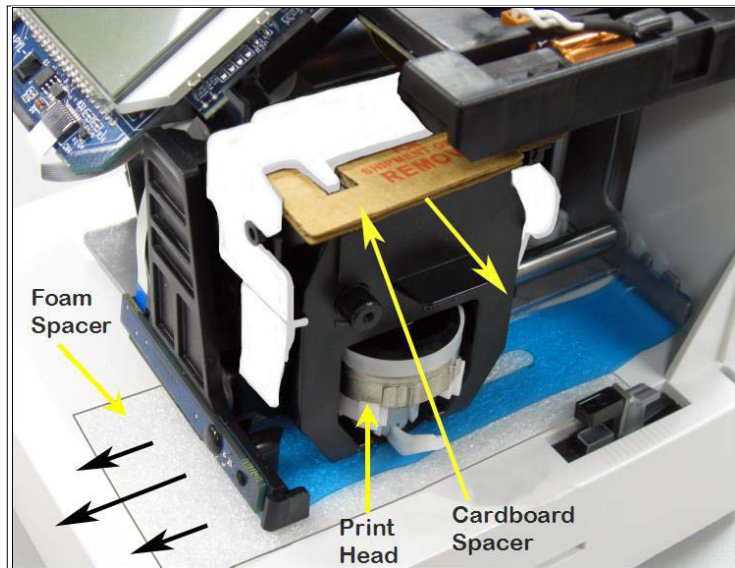

3. Lift up the printer carriage by placing your fingers under the metal motor on the left-hand side and remove the foam spacer (white) located under the print head (Figure). Release the printer carriage.
4. After removing the foam spacer with the cover off **plug in the clock!**



Note –Should the clock not power up, verify that the AC Adapter is plugged into the rear of the clock.



Note – If your PIX-25 is located in an area that cannot receive the Atomic time signal, DO NOT be concerned. The PIX-25 will accurately keep the time using its Quartz mechanism (plus or minus three seconds per week).

When you first receive the clock, it may be necessary to adjust the time so the test printout may not show the accurate time.

Setting the Time (P1)

1. With the cover removed, press and hold the **PROGRAM** button until **P1 TIME** appears to begin programming mode.
2. Press the **ENTER** button one time. The minutes will start flashing (the 2nd line will display **MINUTE**). The seconds will automatically start at zero.
3. Press the **CHANGE** button to increase the minutes to the desired value.
4. Press the **ENTER** button once to accept the current minutes and go to the hours setup mode (the 2nd line will display **HOUR**). The hours will start flashing.
5. Press the **CHANGE** button to increase the hours to the desired value.
6. Press the **ENTER** button once to accept the current hours and go to the **SET DATA** mode. Both the hours and minutes will start flashing.
7. Press the **PROGRAM** button to accept the current time settings, exit programming and return to the normal display or press the **ENTER** button to return to programming mode.



Note – During programming the time should be set depending on the mode the display is currently set in [either 12-hour or 24-hour].

Setting the Date [Month/Date/Year](P2)

1. With the cover removed, press and hold the **PROGRAM** button to begin programming mode and **P1 TIME** will appear.
2. Press the **CHANGE** button to change the current programming mode until the display shows **P2 DATE**.
3. Press the **ENTER** button once and the clock will display the current Month/Date/Year (see right-hand Figure). The year will start flashing (the 2nd line will display **YEAR**). Press the **CHANGE** button to obtain the desired the year value.
4. Press the **ENTER** button once for the month setup mode. The month will start flashing (the 2nd line will display **MONTH**). Press the **CHANGE** button to obtain the desired the month value.



- When the desired month is reached, press the **ENTER** button once to accept the current month and go to the date setup mode (the 2nd line will display **DATE**). The date will start flashing. Press the **CHANGE** button to obtain the desired the date value.
- Press the **ENTER** button once to accept the current flashing date of the month and go to the **SET DATA** mode.
- The Month/Date/Year will start flashing (the 2nd line will display **SET DATA**). Press the **PROGRAM** button to accept the current Month/Date/Year settings, exit programming and return to the normal display or press the **ENTER** button to return to programming mode.

Enabling or Disabling Daylight Saving Time (DST) (P3)



Note – When this setting is set to **ENABLED**, the clock's time will automatically change for Daylight Saving. When this setting is set to **DISABLED**, the clock's time will not change for Daylight Saving.

- With the cover removed, press and hold the **PROGRAM** button to begin programming mode and **P1 TIME** will appear.
- Press the **CHANGE** button to change the current programming mode until the display shows **P3 DST**.
- Press the **ENTER** button and the clock will begin flashing the current Daylight Saving setting (either on or off).
- Press the **CHANGE** button to change the Daylight Saving setting to the desired value of **ENABLED** or **DISABLED**. The default setting = Enabled [ON].
- Press the **ENTER** button to set [save] the current value and go back to the **P3 DST** menu.
- Press the **PROGRAM** button to exit programming or press the **CHANGE** button to go to the next program menu.



Changing the Print Style (P4) 12Hr (Standard) or 24Hr (Military) Default = Preset 1 (12hr)

- With the cover removed, press and hold the **PROGRAM** button to begin programming mode and **P1 TIME** will appear.

2. Press the **CHANGE** button to change the current programming mode until the display shows **P4 PRT STYLE**.



3. Press the **ENTER** button once and the clock will flash the current print format. The default setting =PRESET 1.

4. Press the **CHANGE** button to increase the print preset value from **1** to **2, 3, 4, 5, 6, 7, 8, 9, or 10**.



5. Press the **ENTER** button once to accept the current value.

6. Press the **PROGRAM** button to exit programming or press the **CHANGE** button to go to the next program menu.

There are ten (10) print formats pre-configured to select [Preset 1 thru Preset 10]. Each print style has its own pre-configured print content. See the the following table:

Table: Preset Print Formats

Program #	Presets	Print style sample
Pr-1	2 digit year, month, date 12hr, 60th/hr	`15JAN27 2:25PM
Pr-2	2 digit year, month, date 24hr, 60th/hr	`15JAN27 14:25
Pr-3	2 digit year, month, date 24hr, 100th/hr	`15JAN27 14.42
Pr-4	2 digit year, month, date 24hr, 10th/hr	`15JAN27 14.4
Pr-5	2 digit year, month, date 24hr, 60th/hr, Sec.	`15JAN27 14:25 36s
Pr-6	4 digit year, month, date 12hr, 60th/hr	2015JAN27 2:25PM
Pr-7	4 digit year, month, date 24hr, 60th/hr	2015JAN27 14:25
Pr-8	4 digit year, month, date 24hr, 100th/hr	2015JAN27 14.42
Pr-9	2 digit year, month, date, 6 digit counter	`15JAN27 012345
Pr-10	month, date, 24hr, 60th/hr, 6 digit counter	JAN27 14:25 012345

Note – When the print format is changed, the following settings are overridden:



- The custom symbol printing is overridden by the selected format.
- There will only be one line printed for the selected format.
- The "Print Year", "Print Minute", and "Print Hour" settings will be overridden by the selected pre-defined print format. However, these settings can be changed after selecting the pre-defined print format.

Set Other (PS)

1. With the cover removed, press and hold the **PROGRAM** button to begin programming mode and **P 1 TIME** will appear.
2. Press the **CHANGE** button to change the current programming mode until the display shows **PS OTHER**.
3. Press the **ENTER** button to select the desired other programming mode such as; **P-51** Language, **P-52** Print Direction, **P-53** Paper Detection, **P-54** Leading Zero, **P-55** Numbering, **P-56** Daylight Saving Time Begin, **P-57** Daylight Saving Time End, or **P-58** Display Hour.



Set Print Language (P-51)

1. With the cover removed, press and hold the **PROGRAM** button to begin programming mode and **P 1 TIME** will appear.
2. Press the **CHANGE** button to change the current programming mode until the display shows **PS OTHER**.
3. Press the **ENTER** button once and the clock will flash the **P-51** submenu for language setting (the 2nd line will display **LANGUAGE**).
4. Press the **ENTER** button once and the clock will start flashing the current print language format. The default setting = **L 1 ENGLISH**.
5. Press the **CHANGE** button to change the PRINT LANGUAGE setting to the desired value. Your choices are ENGLISH, SPANISH, FRENCH, PORTUGUESE, ITALIAN, GERMAN, or NUMERIC. See the table for a complete listing of language characters.
6. Press the **ENTER** button once to accept the current displayed value and go back to the previous **P-51 LANGUAGE** submenu.
7. Press the **PROGRAM** button to exit ALL programming or press the **CHANGE** button to go to the next submenu in **PS OTHER**.

Table: Print Languages

	English	Spanish	French	Germany	Italy	Portuguese	Common
Monday	MO	LU	LU	MO	LU	SG	1
Tuesday	TU	MA	MA	DI	MA	TR	2
Wednesday	WE	MI	ME	MI	ME	QU	3
Thursday	TH	JU	JE	DO	GI	QI	4
Friday	FR	VI	VE	FR	VE	SX	5
Saturday	SA	SA	SA	SA	SA	SB	6
Sunday	SU	DO	DI	SO	DO	DO	7
January	JAN	ENE	JAN	JAN	GEN	JAN	1
February	FEB	FEB	FEV	FEB	FEB	FEV	2
March	MAR	MAR	MAR	MAR	MAR	MAR	3
April	APR	ABR	AVR	APR	APR	ABR	4
May	MAY	MAY	MAI	MAI	MAG	MAI	5
June	JUN	JUN	JUN	JUN	GIU	JUN	6
July	JUL	JUL	JUL	JUL	LUG	JUL	7
August	AUG	AGO	AOU	AUG	AGO	AGO	8
September	SEP	SEP	SEP	SEP	SET	SET	9
October	OCT	OCT	OCT	OKT	OTT	OUT	10
November	NOV	NOV	NOV	NOV	NOV	NOV	11
December	DEC	DIC	DEC	DEZ	DIC	DEZ	12
received	RCVD	RCBDO	RECU	EING	RICEV	RCBDO	RCVD
sent	SENT	ENVDO	ENV	AUSG	SPED	ENVDO	SENT
faxed	FAXED	FAX	FAXE	FAX	FAX	FAX	FAXED
void	VOID	ANLDO	ANNUL	LAGER	ANNUL	ANUL	VOID
paid	PAID	PGADO	PAYE	BEZ	PAGA	PAGO	PAID
confirmed	CFM'D	CONF	CONF	EMPF	CONF	CONF	CFM'D
approved	APR'D	APBDO	APPR	BEST	APPR	APRV	APR'D
completed	CMPL'D	TRMDO	TERM	ABGES	COMPL	TERM	CMPL'D
origin	ORIGN	ORIGN	ORIG	ORIG	ORIG	ORIG	ORIGN
file	FILE	ARCH	FICH	AKTE	FILE	ARQV	FILE
in	IN	ENTRA	ENTRE	KOMMT	ENTRA	ENTRA	IN
out	OUT	SALID	SORTI	GEHT	USCIT	SALID	OUT
Used	USED	UTIL	UTIL	GEBRA	UTIL	UTIL	USED

Set Print Direction (P-52)

1. With the cover removed, press and hold the **PROGRAM** button to begin programming mode and **P 1 TIME** will appear.
2. Press the **CHANGE** button to change the current programming mode until the display shows **PS OTHER**.

3. Press the **ENTER** button once and the clock will display the submenu for other settings starting with **P-51 LANGUAGE**.
4. Press the **CHANGE** button once to change the current programming mode so the display shows **P-52 PRINT DIR**.
5. Press the **ENTER** button once and the clock will start flashing the current print direction (RIGHT or LEFT). The default = RIGHT.
6. Press the **CHANGE** button to change the value. Your choices are RIGHT or LEFT.
7. Press the **ENTER** button once to accept the current displayed value and go back to the previous menu **P-52 PRINT DIR**.
8. Press the **PROGRAM** button to exit ALL programming or press the **CHANGE** button to go to the next submenu in **PS OTHER**.



Set Paper Detection (P-53)

The paper detect sensor can be set for Auto or Manual. Amano recommends the default setting of Auto for paper detection. If your PIX-25 is not printing, make sure you are triggering the paper sensor, which can be changed with this parameter.

1. With the cover removed, press and hold the **PROGRAM** button to begin programming mode and **P1 TIME** will appear.
2. Press the **CHANGE** button to change the current programming mode until the display shows **PS OTHER**.
3. Press the **ENTER** button once and the clock will display the submenu for other settings starting with **P-51 LANGUAGE**.
4. Press the **CHANGE** button to change the current programming mode so the display shows **P-53 PAPER DET**.
5. Press the **ENTER** button once and the clock will start flashing the current print direction (AUTO or MANUAL). The default = AUTO.
6. Press the **CHANGE** button to change the value.
7. Press the **ENTER** button once to accept the current displayed value and go back to the previous menu.
8. Press the **PROGRAM** button to exit ALL programming.



Note – The Manual setting requires you to use the PRINT button when printing.



Caution – When the clock is in the manual print mode print media should be inserted in the clock before the print button is pressed to protect the print head.

Set Print Leading Zero (P-54)

The leading zero setting affects the month (if language is set to numeric), date, and hour printing. The other symbols [year, seconds, minutes, etc.] will ignore this setting and always print a leading zero in front of a single digit.

1. With the cover removed, press and hold the **PROGRAM** button to begin programming mode and **P 1 TIME** will appear.
2. Press the **CHANGE** button to change the current programming mode until the display shows **PS OTHER**.
3. Press the **ENTER** button once and the clock will display the submenu for other settings starting with **P-S 1 LANGUAGE**.
4. Press the **CHANGE** button to change the current programming mode so the display shows **P-54 LEAD ZERO**.
5. Press the **ENTER** button once and the clock will start flashing the current LEADING ZERO setting (OFF or ON). The default = OFF.
6. Press the **CHANGE** button to change the LEADING ZERO setting to the desired value. Your choices are OFF or ON. When it is turned off, the printer will not print a leading zero before a single digit number [example: **Jan 1**].
7. Press the **ENTER** button once to accept the current displayed value and go back to the previous menu.
8. Press the **PROGRAM** button to exit ALL programming.



Set Numbering (P-55)

1. With the cover removed, press and hold the **PROGRAM** button to begin programming mode and **P 1 TIME** will appear.
2. Press the **CHANGE** button to change the current programming mode until the display shows **PS OTHER**.
3. Press the **ENTER** button once and the clock will display the submenu for other settings starting with **P-S 1 LANGUAGE**.

4. Press the **CHANGE** button to change the current programming mode so the display shows **P-55 NUMBERING**.



5. Press the **ENTER** button once and the clock will start flashing the current repeat number setting (R1, R2 or R3). The default = R1. When the repeat number is set = 1, the number will increase +1 after each number printed. When the repeat number is set = 2, the number will increase +1 after twice the same number printed. When the repeat number is set = 3, the number will increase +1 after triple the same number printed.



6. Press the **ENTER** button once to accept the current displayed value and go back to the previous menu.
7. Press the **PROGRAM** button to exit ALL programming.

Changing Begin Date for Daylight Saving Time (P-56)

Note – The government standard for Daylight Saving is subject to change. Your clock is factory set for correct Daylight Saving based upon when it was manufactured, but any revision to Daylight Saving beginning or ending dates may require updating the system-set Daylight Saving calendar. The default start date setting = March 08, 2015 at 2:00AM, which is the second Sunday of March, 2015.





If the current year and date has been changed, the available daylight saving start/end date will be automatically updated as well.

The PIX-25 during DLS advance/rollback at 2:00 AM will only shift 1 hour.

If the DLS feature is enabled and the user sets the same start/end dates, the clock will not change its time on the start/end date.

The following steps change the begin date for Daylight Saving. Updating the beginning date for Daylight Saving needs to be done just one time, since the clock's rolling calendar function will auto-calculate the beginning date for each year thereafter. To change the *end* date for Daylight Saving, refer to the next section.

1. With the cover removed, press and hold the **PROGRAM** button to begin programming mode and **P1 TIME** will appear.
2. Press the **CHANGE** button to change the current programming mode until the display shows **PS OTHER**.

3. Press the **ENTER** button once and the clock will display the submenu for other settings starting with **P-51 LANGUAGE**.
4. Press the **CHANGE** button to change the current programming mode until the display shows **P-56 DST BEGIN**. 
5. Press the **ENTER** button once and the clock will start flashing the current year setting.
6. Press the **CHANGE** button to change the current setting if desired.
7. Press the **ENTER** button once and the month will start flashing. Press the **CHANGE** button to change the current month value if desired.
8. Press the **ENTER** button once and the date will start flashing. Press the **CHANGE** button to change the current date value if desired.
9. Press the **ENTER** button once and the month/date/year will flash with **SET DATA** displayed on the 2nd line. 
10. Press the **ENTER** button once to complete the set DST Begin Date mode and go to the previous menu.
11. Press the **CHANGE** button once to move to next menu for setting DST End Date.



Note – In order for the Daylight Saving Time feature to function correctly, both Begin and End dates need to be programmed.

Changing End Date for Daylight Saving Time (P-57)

Note – The government standard for Daylight Saving is subject to change. Your clock is factory set for correct Daylight Saving based upon when it was manufactured, but any revision to Daylight Saving beginning or ending dates may require updating the system-set Daylight Saving calendar. The default end date setting = November 1, 2015 at 2:00AM, which is the first Sunday of November, 2015.

If the current year and date has been changed, the available daylight saving start/end date will be automatically updated as well.



The PIX-25 during DLS advance/rollback at 2:00 AM will only shift 1 hour.

If the DLS feature is enabled and the user sets the same start/end dates, the clock will not change its time on the start/end date.

The steps below change the ending date for Daylight Saving. Updating the ending date for Daylight Saving needs to be done just one time, since the clock's rolling calendar function will auto-calculate the end date for each year thereafter. To change the *begin* date for Daylight Saving, refer to the previous section.

1. With the cover removed, press and hold the **PROGRAM** button to begin programming mode and **P 1 TIME** will appear.
2. Press the **CHANGE** button to change the current programming mode until the display shows **PS OTHER**.
3. Press the **ENTER** button once and the clock will display the submenu for other settings starting with **P-S 1 LANGUAGE**.
4. Press the **CHANGE** button to change the current programming mode until the display shows **P-S 7 DST END**.
5. Press the **ENTER** button once and the clock will start flashing the current year setting.
6. Press the **CHANGE** button to change the current setting if desired.
7. Press the **ENTER** button once and the month will start flashing. Press the **CHANGE** button to change the current month value if desired.
8. Press the **ENTER** button once and the date will start flashing. Press the **CHANGE** button to change the current date value if desired.
9. Press the **ENTER** button once and the month/date/year will flash with **SET DATA** displayed on the 2nd line.
10. Press the **ENTER** button once to complete the set DST End Date mode and go to the previous menu.
11. Press the **PROGRAM** button to exit ALL programming.



Note – In order for the Daylight Saving Time feature to function correctly, both Begin and End dates need to be programmed.

Set Display Hour Format (P-58)

1. With the cover removed, press and hold the **PROGRAM** button to begin programming mode and **P 1 TIME** will appear.
2. Press the **CHANGE** button to change the current programming mode until the display shows **PS OTHER**.
3. Press the **ENTER** button once and the clock will display the submenu for other settings starting with **P-S 1 LANGUAGE**.

4. Press the **CHANGE** button to change the current programming mode so the display shows **P-58 DISP HOUR**.
5. Press the **ENTER** button once and the clock will start flashing the current display hour setting (12 Hr or 24 Hr). The default = 12 Hr.
6. Press the **CHANGE** button to change the display hour setting to the desired value. Your choices are 12 Hr or 24 Hr.
7. Press the **ENTER** button once to accept the current displayed value and go back to the previous menu.
8. Press the **PROGRAM** button to exit ALL programming.

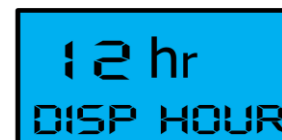
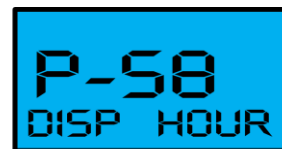

(Note: The Hours Display format can be different than the Hour Print format.)

Customize

The mode of the PIX-25 clock can be entered by removing the top cover and using the programming mode.

1. With the cover removed, press the **PROGRAM** button to begin programming mode and **P1 TIME** will appear.
2. Press the **CHANGE** button to change the current programming mode until the display shows **P6 CUSTOMIZE**. See the following sections for specific.
3. Press the **PROGRAM** button exit programming and return the clock back to normal operation.



Code Program – Custom Printing (P61)

This setting will override the default print setting of the selected print format.

1. With the cover removed, press and hold the **PROGRAM** button to begin programming mode and **P1 TIME** will appear.
2. Press the **CHANGE** button to change the current programming mode until the display shows **P6 CUSTOMIZE**.
3. Press the **ENTER** button once and the clock will display the submenu for other settings starting with **P-61 CODE PROG**.
4. Press the **ENTER** button once and the clock will show the current print year setting (4 digit or 2 digit).



5. If desired, press the **CHANGE** button to change the print digit year setting to the desired value. Your choices are 4 digit or 2 digit. Default = 2 digit yr.
6. Press the **ENTER** button once and the clock will show the print time or print count format setting.
7. If desired, press the **CHANGE** button to select the desired value. Your choices are **TIME PRIN** or **COUNT PRI**.
8. Press the **ENTER** button once and the clock will show the print Day/Date format setting.
9. If desired, press the **CHANGE** button to select the desired value. Your choices are **Day, Date, MNTH DATE, DATE MNTH, DAY DATE, DATE DAY, YR MN DATE, DATE YR MN, MN DAT YR,** or **JULLIAN**.
10. Press the **ENTER** button once and the clock will show the print time format setting.
11. If desired, press the **CHANGE** button to select the desired value. Your choices are **12 HR 10TH, 24HR 10TH, 12HR 20TH, 24HR 20TH, 12HR 60TH, 24HR 60TH, 12H 100TH, 24H 100TH, 24 60 SEC,** or **NO TIME**.

The user can set the print minutes from any of the following options:

- 1/10th Minutes – The minutes will be printed in 1/10 format, which means 6 minutes equal to 0.1 hour.
 - 1/20th Minutes – The minutes will be printed in 1/20 format, which means 3 minutes equal 0.05 hour.
 - 1/60th Minutes – The minutes will be printed in 1/60 format (Default), which means 1 minute equals 0:01 hour.
 - 1/100th Minutes – The minutes will be printed in 1/100 format, which means 36seconds equal 0.01 hour.
12. If desired, press the **CHANGE** button to select the desired value.
 13. Press the **ENTER** button once and the clock will show the print symbol format setting = **NO SYMBOL**.
 14. Press the **ENTER** button once and the clock will flash current desired custom the print settings.
 15. Press the **ENTER** button again to accept the print style settings and return back to the **P6 CUSTOMIZE** menu.
 16. Press the **PROGRAM** button exit programming and return the clock back to normal operation.

Setting Custom Print (Symbol Printing) (P62)

1. With the cover removed, press and hold the **PROGRAM** button to begin programming mode and **P 1 TIME** will appear.
2. Press the **CHANGE** button to change the current programming mode until the display shows **P6 CUSTOMIZE**.
3. Press the **ENTER** button once and the clock will display the submenu for other settings starting with **P-6 1 CODE PROG**.
4. Press the **CHANGE** button once and the clock will display **P62 SYMBOL PR**.
5. Press the **ENTER** button once and the clock will show the current symbol selected for digit 1.
6. If desired, press the **CHANGE** button to change the desired symbol for digit 1.
7. Press the **ENTER** button once and the clock will show the symbol for digit 2.
8. If desired, press the **CHANGE** button to select the desired value for 2.
9. Press the **ENTER** button once and the clock will show the symbol for digit 3.
10. If desired, press the **CHANGE** button to select the desired value for 3.
11. Press the **ENTER** button once and the clock will show the symbol for digit 4. This process can continue until the maximum printing length of 154 dots is reached.
12. Press the **PROGRAM** button exit programming and return the clock back to normal operation.



Note – Pressing the **PROGRAM** button while performing custom print line setup with symbol printing will end the custom print submenu without altering the program.

PIX-25 Symbol Printing

All available symbols are listed in the following table with the length expressed in dots and percent of maximum line length allowed (160 dots).

Table: Symbols

Displayed/Printed Symbol	Description	Length in Dots
2D YEAR	2-digit Year	25 = 16.45%
4D YEAR	4-digit Year	40 = 26.67%
MONTH	Month	30 = 19.74%
DATE	Date	20 = 13.16%
DAY	Day of Week	20 = 13.16%
JULIAN	Julian Date	30 = 19.74%
10MIN 12HR	12 Hr. and 10th/Hr.	49 = 32.24%
20MIN 12HR	Skip, Not Applicable	59 = 38.82%
60MIN 12HR	12 Hr. and 60th/Hr.	59 = 38.82%
100MIN 12H	12 Hr. and 100th/Hr.	59 = 38.82%
10MIN 24HR	24 Hr. and 10th/Hr.	35 = 23.03%
20MIN 24HR	Skip, Not Applicable	45 = 29.61%
60MIN 24HR	24 Hr. and 60th/Hr.	45 = 29.61%
100MIN 24H	24 Hr. and 100th/Hr.	45 = 29.61%
SECOND	Second	27 = 18.00%
RCVD	RCV'D	43 = 28.29%
SENT	SENT	40 = 26.32%
FAXD	FAX'D	43 = 28.29%
VOID	VOID	40 = 26.32%
PAID	PAID	40 = 26.32%
CFMD	CFM'D	43 = 28.29%
APRD	APR'D	43 = 28.29%
CMPLD	CMPL'D	53 = 34.87%
ORIGN	ORIGN	50 = 32.89%
FILE	FILE	40 = 26.32%
IN	IN	20 = 13.16%
OUT	OUT	30 = 19.74%
USED	USED	40 = 26.32%
SPACE	Space ()	03 = 1.97%
BLOCK	Field Divider (■)	07 = 4.61%
DASH	Dash (-)	10 = 4.61%
SLASH	Slash (/)	10 = 6.58%
ADD	Add a Character	-
DEL	Delete a Character	-
END	End of File	0 = 0%

Each symbol has a number of dots associated with it for printing. During line configuration, each line allows the user to select the maximum number of symbols, whose total doesn't exceed the maximum number of 154 dots. During the line configuration, only those symbols will appear for selection, which can comprise the total number of 154 dots per print line.

Table: Imprint Examples Using Symbol Printing

Print Style	Style Sample	Code to Enter
Day, 12hr, 60th/hr	FR 1:45 _{PM}	DAY•SPACE•12HR60TH•END
Day, 24hr, 60th/hr	FR 13:45	DAY•SPACE•24HR60TH•END
Day, 24hr, 10th/hr	FR 13.7	DAY•SPACE•24HR10TH•END
Day, 24hr, 100th/hr	FR 13.75	DAY•SPACE•24HR100TH•END
Date, 12hr, 60th/hr	13 1:45 _{PM}	DATE•SPACE•12HR60TH•END
Date, 24hr, 60th/hr	13 13:45	DATE•SPACE•24HR60•END
Date, 24hr, 10th/hr	13 13.7	DATE•SPACE•24HR10TH•END
Date, 24hr, 100th/hr	13 13.75	DATE•SPACE•24HR100TH•END
Month, Date, 12hr, 60th/hr	APR13 1:45 _{PM}	MONTH•SPACE•DATE•SPACE•12HR60TH•END
Month, Date, 24hr, 60th/hr	APR13 13:45	MONTH•SPACE•DATE•SPACE•24HR60TH•END
Date, Month, 24hr, 10th/hr	13 APR 13.7	DATE•SPACE•MONTH•SPACE•24HR10TH•END
Date, Month, 24hr, 100th/hr	13 APR 13.75	DATE•SPACE•MONTH•SPACE•24HR100TH•END
2digit Year, Month, Date, 12hr, 60th/hr	'15 APR 13 1:45 _{PM}	2D-YEAR•SPACE•MONTH•SPACE•DATE•SPACE•12HR60TH•END
2digit Year, Month, Date, 24hr, 60th/hr	'15 APR 13 13:45	2D-YEAR•SPACE•MONTH•SPACE•DATE•SPACE•24HR60TH•END
4digit Year, Month, Date, 24hr, 10th/hr	2015 APR13 13.7	4D-YEAR•SPACE•MONTH•SPACE•DATE•SPACE•24HR10TH•END
2digit Year, Month, Date, RCV'D	'15 APR13 RCV'D	2D-YEAR•SPACE•MONTH•SPACE•DATE•SPACE•RCV'D•END
4digit Year, Month, Date, SENT	2015 APR13 SENT	4D-YEAR•SPACE•MONTH•SPACE•DATE•SPACE•SENT•END
2digit Year, Month, Date, Space, Divider, Space, 12hr, 60th/hr	'15JAN08 ■ 12:47 _{PM}	2D-YEAR•MONTH•DATE•SPACE•BLOCK•SPACE•12HR60TH•END
2digit Year, Month, Date, Space, Divider, Space, 24hr, 60th/hr	'15OCT24 ■ 22:09	2D-YEAR•MONTH•DATE•SPACE•BLOCK•SPACE•24HR60TH•END
2digit Year, Month, Date, Space, Divider, Space, 24hr, 100th/hr	'15OCT24 ■ 14.16	2D_YEAR•MONTH•DATE•SPACE•BLOCK•SPACE•24HR100TH•END
4digit Year, Month, Date, Space, Divider, Space, 24hr, 10th/hr	2015OCT24 ■ 20.1	4D-YEAR•MONTH•DATE•SPACE•BLOCK•SPACE•24HR10TH•END
Day, Space, Divider, Space, 24hr, 100hr/hr	FR ■ 20.17	DAY•SPACE•BLOCK•SPACE•24HR100TH•END
RCV'D, Space, Block, Space, 12hr, 60th/hr, Seconds	RCV'D ■ 11:35 _{AM} 24s	RCV'D•SPACE•BLOCK•SPACE•12HR60TH•SECONDS•END
Counter, Block, Month, Date, 2digit Year	012345■AUG23`15	6D-COUNT•BLOCK•MONTH•DATE•2D-YEAR•END
Counter, Slash, 4digit Year, Month, Date	012345/2015AUG23	6D-COUNT•SLASH•4D-YEAR•MONTH•DATE•END

Diagnostics

The diagnostic mode of the PIX-25 clock can be entered by removing the top cover and using the programming mode.

4. With the cover removed, press the **PROGRAM** button to begin programming mode and **P1 TIME** will appear.
5. Press the **CHANGE** button to change the current programming mode until the display shows **P1 DIAGNOSE**. See the following sections for specific diagnostics.
6. Press the **PROGRAM** button exit programming and return the clock back to normal operation.



Main Board Version (d1)

Use this test to check the firmware version of the main board (Freescale) microcontroller.

1. With the cover removed, press and hold the **PROGRAM** button to begin programming mode and **P1 TIME** will appear.
2. Press the **CHANGE** button to change the current programming mode until the display shows **P1 DIAGNOSE**.
3. Press the **ENTER** button once to display **D1 SOFT REV** menu
4. Press the **ENTER** button once and the clock will display the current firmware version (see Figure example on right).
5. Press the **ENTER** button to go back to the **D1 SOFT REV** menu.
6. Press the **PROGRAM** button to exit programming or press the **CHANGE** button to go to the next diagnostic sub program menu.



LCD Test (d2)

Use this diagnostic to check the PIX-25 LCD display by turning on all segments.

1. With the cover removed, press and hold the **PROGRAM** button to begin programming mode and **P1 TIME** will appear.
2. Press the **CHANGE** button to change the current programming mode until the display shows **P1 DIAGNOSE**.

3. Press the **ENTER** button to display **D1 SOFT REV** sub menu.
4. Press the **CHANGE** button and the clock will display **D2 LCD TEST** (see Figure example on right).
5. Press the **ENTER** button to show all the LCD display characters.
6. Press the **ENTER** button to go back to the **D2 LCD TEST** menu.
7. Press the **PROGRAM** button to exit programming or press the **CHANGE** button to go to the next diagnostic sub program menu.



Show Number Printed (d3)

Use this diagnostic to check the amount of PIX-25 printing.

1. With the cover removed, press the **PROGRAM** button to begin programming mode and **P1 TIME** will appear.
2. Press the **CHANGE** button to change the current programming mode until the display shows **P7 DIAGNOSE**.
3. Press the **ENTER** button to display the **D1 SOFT REV** sub menu.
4. Press the **CHANGE** button until the clock will displays **D3 NUM PRINT** (see Figure example on right).
5. Press the **ENTER** button once and the clock will display the total number of prints with **TOTAL PRT** flashing on the bottom line.
6. Press the **ENTER** button once to exit and go back to the previous menu.
7. Press the **PROGRAM** button to exit ALL programming or press the **CHANGE** button to go scroll through sub menu options for **P7 DIAGNOSE**.



Clear Memory (d4)

Use this diagnostic to clear memory and to reset defaults.

1. With the cover removed, press and hold the **PROGRAM** button until **P1 TIME** appears to begin the programming mode.
2. Keep pressing the **CHANGE** button to change the current programming mode until the display shows **P7 DIAGNOSE**.
3. Press the **ENTER** button once and the clock will display the sub menu **D1 SOFT REV**.
4. Keep pressing the **CHANGE** button until the display shows **D4 CLEAR**.



5. Press the **ENTER** button once and the clock will display **00** with the first digit flashing.
6. Keep pressing the **CHANGE** button until the display shows the desired first digit such as **3**.
7. Press the **ENTER** button once to advance to the 2nd digit. Keep pressing the **CHANGE** button until the display shows the desired 2nd digit such as **2**.
8. Press the **ENTER** button so both digits flash.
9. Press the **ENTER** button to perform the clear function and exit ALL programming. By entering code 32, the clock resets all user settings (except the total print number and date time) to the factory defaults settings. The clock displays the message "**WAIT**" and "**RESET**" on the LCD screen and restarts. Note: If an invalid two digit password is entered the display will flash "**ERROR**".
 - Enter **03** to disable the atomic clock.
 - Enter **04** to enable the atomic clock.
 - Enter **11** to turn on display atomic sync.
 - Enter **12** to turn off display atomic sync.
 - Enter **13** to reset 6 digit count.
 - Enter **32** to clear memory.
 - Enter **98** to clear all parameters plus the total print number.



Note FAQ – If the Atomic Clock feature has been turned off, pressing the "Reset" button or changing the time will not turn the feature back on. The feature must be Enabled by following the above steps.

Warning Message (d5)

Use this diagnostic to check the PIX-25 LCD for any warning messages.

1. With the cover removed, press and hold the **PROGRAM** button until **P1 TIME** appears to begin the programming mode.
2. Keep pressing the **CHANGE** button to change the current programming mode until the display shows **P1 DIAGNOSE**.
3. Press the **ENTER** button once and the clock will display the sub menu **D1 SOFT REV**.
4. Keep pressing the **CHANGE** button until the display shows **D5 WARNING**.
5. Press the **ENTER** button once and the clock will display the most recent warning message. If there are no warning messages, the clock will display the text **NONE**.



6. Press the **ENTER** button once to exit and go back to the previous menu.
7. Press the **PROGRAM** button **once** to exit ALL programming or press **CHANGE** button to go scroll through the remaining sub menu options for **P1 DIAGNOSE** and/or programming modes again.

Advanced Diagnostics (d6)

Since the **ADVANCED DIAGNOSTICS area** is not intended to be accessed by the casual user, the menu selection sequence is a bit different than selections **d1 – d5** above. Refer to each of the sections below for the proper sequence to navigate through data entry.

1. With the cover removed, press and hold the **PROGRAM** button until **P1 TIME** appears to begin the programming mode.
2. Keep pressing the **CHANGE** button to change the current programming mode until the display shows **P1 DIAGNOSE**.
3. Press the **ENTER** button once and the clock will display the sub menu **D1 SOFT REV.**
4. Keep pressing the **CHANGE** button until the display shows **D6 ADVANCE.**
5. Press the **ENTER** button once to enter the diagnostic mode. The clock will prompt the user to enter a 2-digit code by first flashing the lefthand digit on the bottom line. Change the first digit of the code using the **CHANGE** button until the display shows the correct code number in the left-hand digit. Press the **ENTER** button once and repeat the same function to select the right hand digit, then press the **ENTER** button once to perform the diagnostics for the codes listed below.
6. Press the **PROGRAM** button **once** to exit ALL programming or press **CHANGE** button to go scroll through the programming menus.

NOTE:

- **Invalid Codes**

By entering any other code than mentioned, the clock will display a message "UNKNOWN". Press the **ENTER** button to display "ERROR" and go back to the previous menu **D6 ADVANCE** without performing any action. Repeat step 5 above and enter the correct code.

- **Display Contents of Reset Tracking Parameters (Code 42)**

By entering code 42, the entire set of tracking data will be displayed on the LCD screen, pausing 2 seconds per parameter.

- **Clear Reset Tracking Data (Code 43)**

By entering code 43, all data from current tracking parameters will be cleared. It will not clear data from the initial tracking data.

- **Clear Custom Data (Code 44)**

By entering code 44, all custom data will be cleared.

Acceptable Print Media

Print Media is defined as the type of material you will be using in the machine to time stamp (time cards, documents, etc.). To avoid damaging the print head, it is recommended that you do not exceed a media thickness of 0.3 mm (0.01"). The following are general specifications for the different media dimensions.

- **Time Card:** Time card thickness less than or equal to 0.3 mm (0.01").
- **Small Ticket:** Tickets, slips, receipts or other validation media should be no smaller than 100 mm (4") long x 60 mm (2.25") wide.
- **Larger Paper:** When using standard paper sizes, such as 8.5" x 11", if the weight of the paper (thickness) is too light, the paper will curl up and tear off inside the PIX-25 clock. This may result in jams or damage to the clock.



Note – Amano recommends using the manual print method (see "Setting the Print Method") for large paper and transparent media printing.

- **Carbon Paper:** The PIX-25 clock will print on both carbon and carbonless paper. The imprint will print through up to four copies, depending on the quality of the document used. Carbon and carbonless paper deteriorates over time. Humidity, high temperatures and sunlight accelerate this process. For maximum print performance, use only high grade, uncontaminated carbon or carbonless paper.

Atomic Clock Feature (Not available in HI and AK)

The atomic clock receives time signals on long wave radio (60 kHz) from the National Institute of Standards and Technology (NIST) radio station WWVB, located in Fort Collins, Colorado, which is coupled with the atomic cesium clock in Boulder; no other time-code signal is supported. The PIX-25 receives the WWVB time signal via its built-in antenna system. Your clock will try to find the signal continuously if this feature is enabled.



When the clock is powered on, the time is changed, or the **Reset** button is

pressed, the clock receiver is enabled to acquire the Atomic Time Synchronization signal, and the indicator will display the triangle tower symbol. Once the correct minutes and seconds [time] is received the curved wave symbol will be displayed with the tower.

If your PIX-25 is located in an area that cannot receive the Atomic time signal, DO NOT be concerned, since the PIX-25 is able to accurately keep the time using its quartz mechanism (plus or minus three (3) seconds per week).

Please visit <http://tf.nist.gov/stations/radioclocks.htm> for more information about how radio-controlled clocks work, where they work, and what to do when they don't work.

Inappropriate places to keep the unit for atomic signal

Please note that the clock may be unable to receive radio wave signals properly under the following conditions.

- Inside a large building, between tall buildings, underground or in buildings without windows.
- Close to overhead power lines, TV stations and train cables.
- Close to home electrical appliances or devices such as TV's, PC's, refrigerators or fax machines.
- Close to furniture made of steel, such as a steel desk.
- In places generating radio interference, such as near construction sites, airports or in heavy traffic.
- Inside a vehicle, train or airplane.

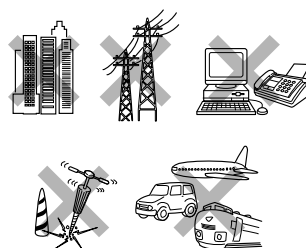

To help enhance signal reception, Amano recommends facing the clock display in either South or North direction.

Ribbon Cartridge Replacement

Step 1. Insert the clock key and turn clockwise to unlock the cover, lift up the cover, and remove for ribbon access. Locate the ribbon cradle.



Note – You MUST have the key to remove the cover for ribbon replacement.

The Amano PIX-25 clock pictured in the Figure (below) shows a typical layout with the ribbon cartridge in the cradle.

Step 2. Press up on the release clips then grasp the tab on the ribbon cartridge. Pull the ribbon cartridge out of the cradle (see right-hand Figure and arrows).

Step 3. Insert a new ribbon cartridge and be sure to guide the ribbon between the ribbon shield and the printer head as illustrated (see right-hand Figure and arrows).



Step 4. Turn the knob on the cartridge clockwise one turn to take up any slack in the ribbon (see right-hand Figure).

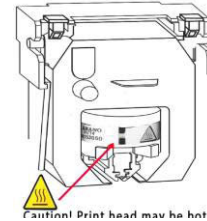

Step 5. Stamp a card to check the printing quality and confirm that you have installed the ribbon cartridge properly.



Note – If the print mechanism is down (a piece of paper could not be inserted), press the **RESET** button to move the carriage to the up position. This will make the ribbon cartridge installation easier.

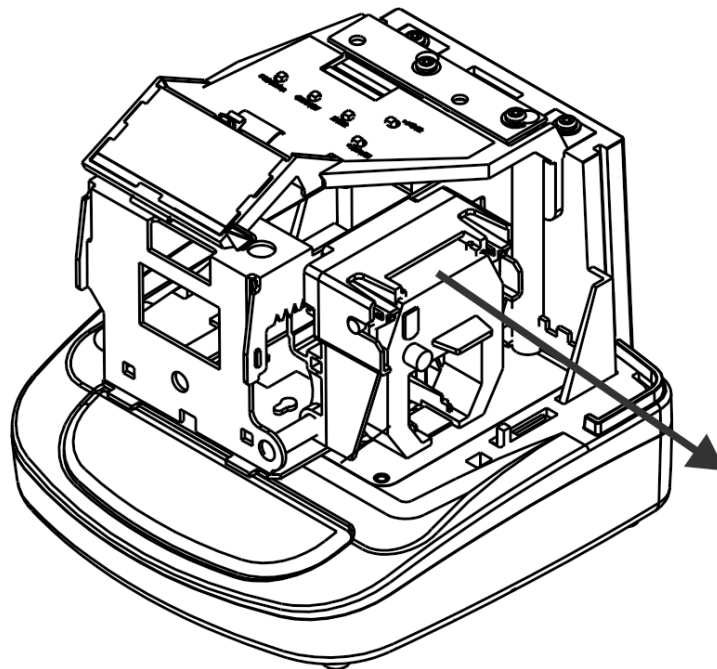

Figure: PIX-25 Ribbon Cradle Location.

Parts

Need Ribbons, Keys and Accessories?
Visit
www.amano.com/time
Or call 1-800-253-9836

The PIX-25 ribbon cartridge in **Black** ink is Amano Part No. **CE-315151**
The PIX-25 ribbon cartridge in **Red** ink is Amano Part No. **YK-629671**
The PIX-25 ribbon cartridge in **Green** ink is Amano Part No. **YK-629771**
Ribbon cartridges are good for approximately 9,000 stamps, and are supplied in sealed plastic to provide an average shelf life of 2 plus years.

The Amano Part number for a set of PIX-25 replacement keys is **AJR-201150**



Note – A key is required to unlock the top cover which allows you access to the ribbon cartridge for replacement as well as the buttons for programming.

The Amano Part number for a replacement Ribbon Shield (see Figure 3) is **AJR-600600**.

When ordering parts and/or accessories, be sure to include your PIX-25 model number.

Error Messages

In the event of an error, a message will appear in the display. The possible error messages are listed in the following table along with their probable causes and solutions.



Note – An error message can be possibly cleared by pressing the “**Reset**” button. The Reset button is located on the back of the clock on the bottom. The blue Rest button is recessed, so it may require using an object such as the tip of a ballpoint pen to press.

For error messages **Print Error E 01** through **Print Error E 04**, unplug the clock before checking to see that the carriage is not stuck or jammed. Also, check to see that the ribbon cables are in good condition. After clearing any jams, plug the clock back in. Contact us at **1-800-253-9836** if you need assistance.

Table: Error Messages

Error	Cause	Solution
Er 01	Home Position Error, Carriage Stuck.	Unlock cover and remove. Set PIX-25 on its side with the ribbon side up. Press the Reset button to reset the printer carriage and blow air into the printer platen (see Error! Reference source not found. on page 2-23) to remove or dislodge jammed objects (i.e., staples).
Er 02	DOT Timing Sensor Error, Carriage Stuck.	Unlock cover and remove. Set PIX-25 on its side with the ribbon side up. Press the Reset button to reset the printer carriage and blow air into the printer platen (see Error! Reference source not found. on page 2-23) to remove or dislodge jammed objects. If the error reoccurs, check the wires and cables to verify all components are connected properly.
Er 03	Home Position Sensor.	Unlock cover and remove. Press the Reset button to reset the printer carriage and the time should reappear on the display. Try to stamp a card again so you can hear the machine attempting to stamp.
Er 04	Carriage Stuck.	User has configured clock for symbol printing without entering a symbol for line 1 or line 2. Select predefined print format or re-configure symbol printing.
Er 05	General Print Error.	User has configured clock for symbol printing with more than the allowed number of dots per line. This error could also occur with a pre-defined print format and overwriting print minutes/year format. To correct the problem, select a pre-defined print format or enter less than 160 dots per line. If this error occurs the clock will ignore the print request and display the error. Press reset or reset power.
Er 06	Daylight Saving Time Program Error.	User has attempted to get into the Program mode during the Daylight Saving changeover one-hour lockout. Wait one hour to program the clock

PIX-25 Support

Should you need further assistance in clearing an error message:

1. Visit our website at: www.amano.com/time or find more information at www.amano.com/tkb
2. Call us at: **1 (800) 253-9836**
 - Monday – Friday 8:15am – 5:00pm (EST)
3. E-mail us at: tkb@amano.com

PIX-25 Cleaning

Do not use any chemical solvents or oils to clean or lubricate your PIX-25. This will damage your clock. To clean the inside of your clock, simply blow it out with air.

Resetting Clock After Extended Loss of Power

If there has been an AC power interruption sufficient to drain the internal lithium battery, the date setting, and the clock setting will need to be reset.

PIX-25 Power Modes

Power On Mode

During this mode where the clock has power from the AC power adapter, the clock will have all functionality and the display will show the current time, date, weekday, ink level, atomic clock signal level, etc.

Power Off Mode

During this mode where the clock has NO power from the AC power adapter, the clock will have NO functionality and the display will be off. The clock will continue to run on the internal coin battery to retain the correct time and user settings. Upon restoring the AC power, the clock will return to normal operation.



Note – If the clock does not have AC power and the coin battery is dead, the clock will lose all user settings and the time and date will revert to displaying the factory default setting of **Jan 1, 2011, 12:00 AM** when the AC power is restored. The maximum amount of time the clock can preserve the user settings with the battery is 2 years (see Specifications).

PIX-25 Time Display Modes

The time will always be displayed on the PIX-25 LCD display when the clock is connected to AC power.

12 Hour Format

In the 12 hour time format, the hours will be displayed up to 12 with the letters "AM" or "PM". For example, 12:05AM and 5:25 PM (see Figure).



24 Hour Format

In the 24 hour time format [alias "military time"], the hours will be displayed up to 23. The time after 12 hours would be considered "PM". For example, 17:25 (see Figure) = 5:25 PM, 12:00 = 12:00 (noon), 00:01 = 12:01 AM, and etc.

Wall Mounting

Remove the rear plate of the PIX-25 and use it as a template for wall mounting. Located and press the Tab on the bottom of the clock to help release the rear wall mounting plate.

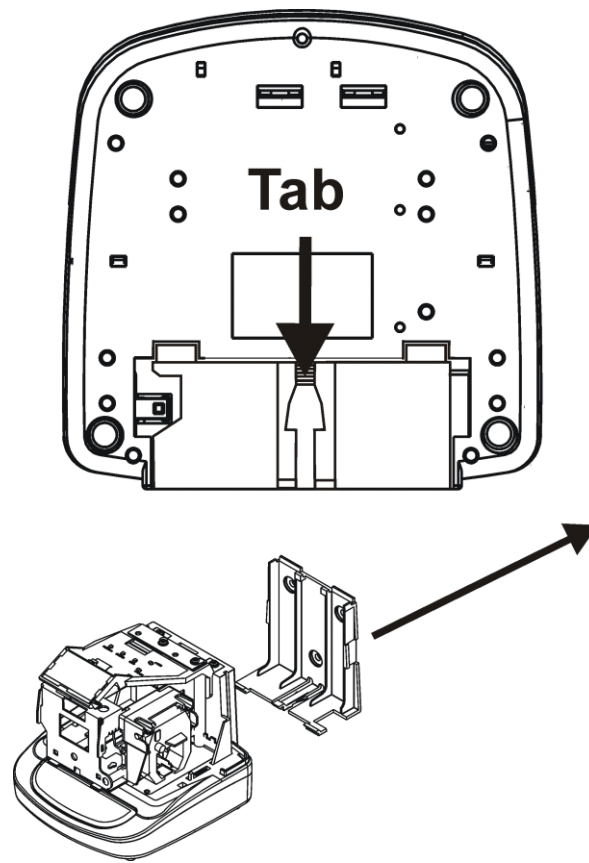

Figure: PIX-25 Clock Bottom

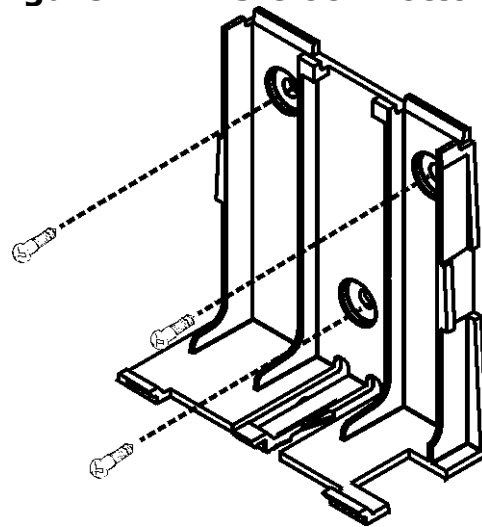

Figure: PIX-25 Clock Back Removed for Wall Mounting

PIX-25 Programable Features Summary

The following table summarizes the PIX-25 features that are user programmable in the programming mode.

Feature (Menu Item)	Description
P1 TIME CHANGE	Set the displayed clock time.
P2 DATE CHANGE	Set the clock date [Month/Date/Year].
P3 DAYLIGHT SAVING	Enable/disable automatic Daylight Saving adjustment.
P4 PRINT STYLE	Select 1 of 6 pre-defined print formats for single line printing.
P5 OTHER	Access submenu items for additional features.
P-51 PRINT LANGUAGE	Select the language to print pre-formatted and custom symbol print.
P-52 PRINT DIRECTION	Select print direction (left or right).
P-53 PAPER DETECTION	Setup method PIX-25 uses to detect paper for printing.
P-54 LEADING ZERO	Enable/disable leading zero from being printed.
P-56 DST BEGIN DATE	Change DLS start date from factory default setting.
P-57 DST END DATE	Change DLS end date from factory default setting.
P-58 DISPLAY HOUR	Select displayed hour format (12 Hr or 24 Hr). Display can be different from print.
P6 CUSTOMIZE	Select displayed hour format. Display can be different from print.
P61 CODE PROGRAM	Setup custom symbol print format for a maximum of two (2) print lines. Also, used to add and delete symbols or print line.
P62 SYMBOL PROGRAM	Select displayed hour format. Display can be different from print.
P7 DIAGNOSE	Access submenu items for additional features
D1 SOFTWARE VERSION	Check firmware version of main board.
D2 LCD TEST	Test each segment of LCD display.
D3 NUMBER PRINTS	Check total number of prints.

Feature (Menu Item)	Description
D4 DATA CLEAR	Disable atomic clock, enable atomic clock, turn on display atomic sync, turn off display atomic sync, reset 6 digit count, clear memory, and/or all clear.
D5 SHOW WARNING MESSAGE	Displays the most recent warning message
D6 ADVANCED	Advanced diagnostics (factory codes) to display reset tracking data, clear reset tracking data, and/or clear custom data.

Warranty Notice

Any claim for warranty, expressed or implied, due to the clock's failure to properly receive the radio signal because of interference, whatever the source of this interference may be, are hereby expressly excluded.

For more information about the WWVB radio signal, actual signal coverage in North America visit NIST's website at:

<http://tf.nist.gov/stations/radioclocks.htm>

For actual signal coverage in North America visit:

www.boulder.nist.gov/timefreq/stations/wwvbcovrage.htm

Wall Mounting (Optional)

Avoid the following:

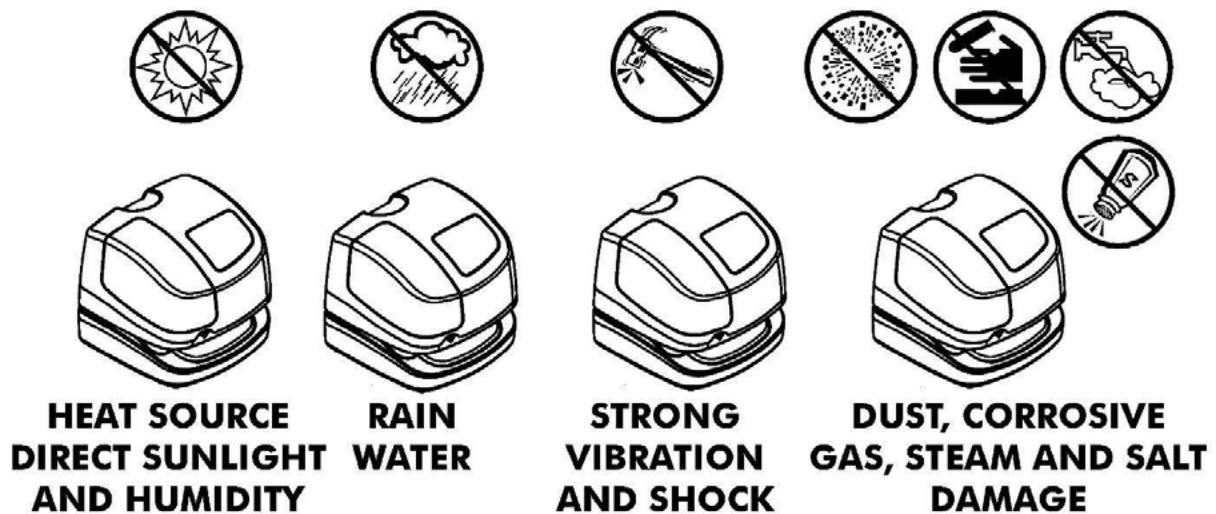

1. Remove the rear mounting plate from the PIX-25 and use it to mark the three (3) mounting holes on the wall.
2. Hang the PIX-25 rear mounting plate level on the wall using #10 wood screws [not included] or equivalent.
3. Verify that the cable for the AC Power Adapter is plugged into the back of the PIX-25 before hanging it on the wall. It should already be secured with a wire tie to the clock base.
4. Carefully replace the cover for normal operation.

Operation

PIX-25 Views

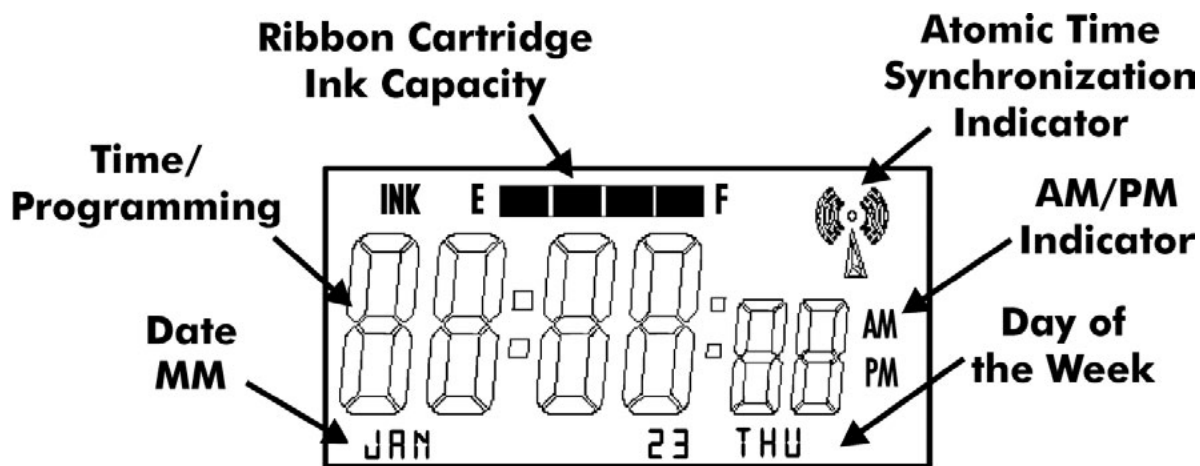

Figure: Display View.

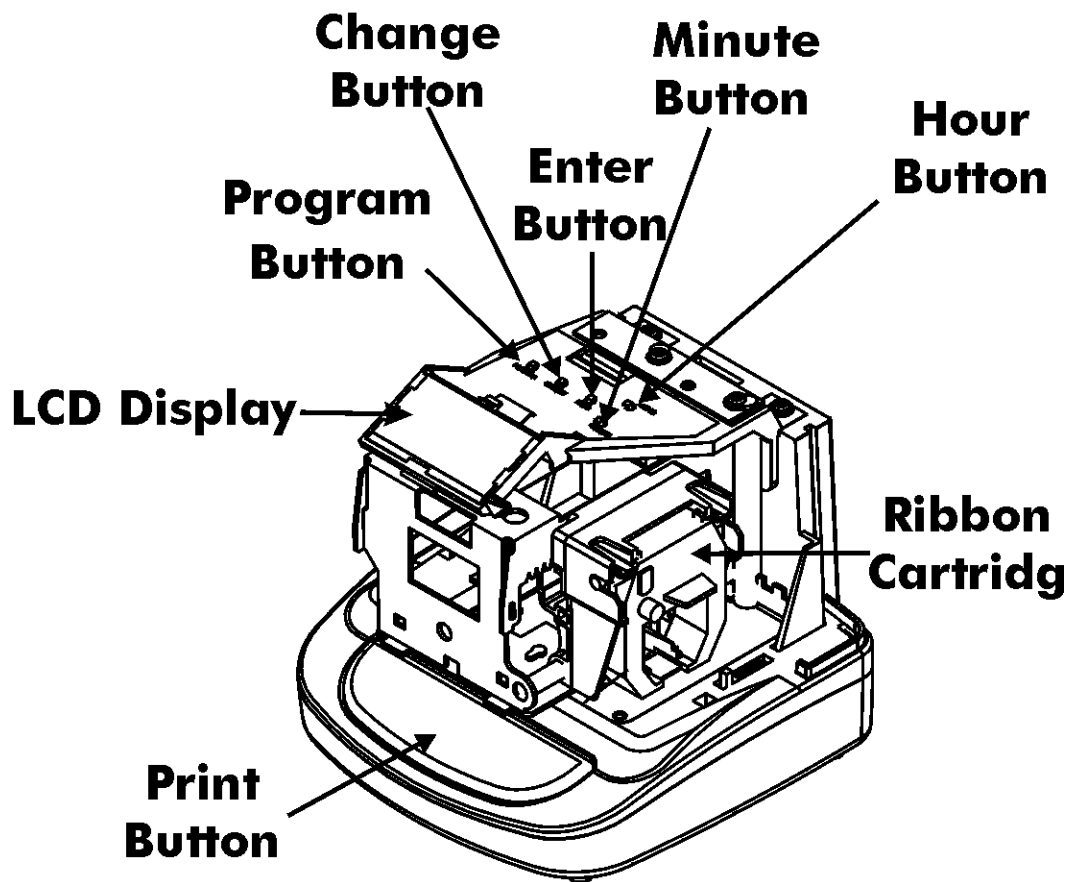

Figure 1: Internal View.

PIX-25 View Description

Internal View

The 4 function buttons are used to navigate through the Setup Mode to change the clock's settings.

- The **PROGRAM** button is used to enter/exit the Program Mode and exit any sub-program menu.
- The **ENTER** button is used to accept the information shown on the display and save it in memory.
- The **CHANGE** button is used to select/advance through information shown on the display.
- The **+1 HOUR** button is used to advance 1 hour per press on the display while not in the programming mode.
- The **+1 MINUTE** button is used to advance 1 minute per press on the display while not in the programming mode.
- The **RESET** button on the bottom rear of the clock will restart the clock with no change to user settings, time, and ink capacity.

Need Ribbons, Keys and Accessories?
Visit

WWW.TIMECLOCKEXPERTS.COM : 866-487-4751

The Atomic Time Synchronization Indicator in the LCD Display indicates the status of the signal. When you first receive the clock, it may be necessary to adjust the hour and minute. **This Atomic Time Synchronization feature is not available in Hawaii and Alaska.**

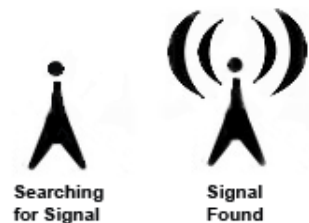

Whenever the time is changed on the clock by the user the "Signal Found" Atomic Time Synchronization Indicator will be turned off and just the "Searching for Signal" indicator will be displayed. The clock will automatically resynchronize the time (minutes and seconds) by searching for the Atomic Time signal.



Note – The atomic clock feature must be enabled for this time synchronization process. Amano recommends facing the front of the clock (display side) either in the South or North direction to increase potential atomic time signal reception.

Warranty Information

Limited Warranty Statement: Amano Cincinnati, Inc. warrants this equipment to be free from defects in materials and workmanship for a period of one year from the date of purchase from an authorized distributor. If the equipment fails within the one year period, Amano Cincinnati, Inc will, at its sole option, replace or repair at no charge, the equipment which, in its sole discretion is determined to be defective.

There are no other warranties expressed or implied and Amano Cincinnati, Inc. disclaims any and all other warranties including, without limitations, implied warranties of merchantability and fitness or a particular purpose. Under no circumstances will Amano Cincinnati, Inc. be liable for consequential, incidental or similar damages, including lost savings, profits or other damages caused by use in connection with the product or the ability to use the product, even if the distributor or Amano Cincinnati, Inc. has been advised of such potential liability or other claims, repair or replacement constitutes your sole and exclusive remedy. Some states do not allow the limitation or exclusion of liability for incidental or consequential damages, so the above limitation or exclusion may not apply to you.

During the one year period of warranty, Amano Cincinnati, Inc., will, at its sole option, replace or repair the returned product at no charge if it is determined by Amano Cincinnati, Inc. that the product has failed due to defects in materials and workmanship. If the failure is for any other reason, Amano Cincinnati, Inc. shall repair or replace the returned product and will charge a fee to cover repair or replacement, handling and service based upon its current price schedule in effect at the time of repair or replacement. Amano Cincinnati, Inc. reserves the right, at its sole option, to replace the returned product with a current product having similar features and functionality as determined by Amano Cincinnati, Inc. You, the customer are responsible for properly packing the product for shipment and for the charges for shipment and insuring the product during shipment to Amano Cincinnati, Inc. Amano Cincinnati, Inc. is responsible for the charges of shipment the repaired or replaced product back to you if it is determined that the product failed due to defects in materials or workmanship.. If the returned product has been modified without Amano Cincinnati, Inc. written consent or if the failure is the result of misuse, abuse, or misapplication, Amano Cincinnati, Inc. has no obligation to repair or replace the defective product. To obtain warranty service, this registration card must be returned to Amano Cincinnati, Inc. with proof of purchase in the form of an invoice from an authorized Amano Cincinnati distributor. For warranty and non-warranty service, contact the seller from whom you directly purchased the product.

Any replacement or parts become the property of Amano Cincinnati, Inc.

Specifications

Power Requirements

For Clock Input:	15 VDC, 1.2A (Max.)
For AC Adapter:	100 - 240 VAC, 50/60Hz
Battery:	Lithium Battery for Memory Backup in case of power failure (factory installed). Shelf life of 2 years.

Ambient Temperature: -10°C to 45°C (14°F to 113°F)

Ambient Humidity: 10% to 90% (non-condensing)

Clock Accuracy: ± 3 seconds/week on AC Power
± 10 seconds/week on Lithium

Dimensions: 6-11/16"(170 mm) Wide X 6- 7/16" (163 mm) High X 6-5/8"(168 mm) Deep.

Weight: Approximately 3.6 lbs. (1.63 kg)

Environment: Indoor use only; dust-free environment. Keep out of direct sunlight.

Standards Compliance:





Search the Knowledge Base

Find answers to frequently asked questions, and general product information such as a basic operation guide for this product at: www.amano.com/tkb



Service and Support

Contact us by; phone @ 800 253-9836, Mon – Fri.

8:15 am – 5pm EST

E-mail: tkb@amano.com

PRODUCT REGISTRATION

Protect Your Investment

Register your product for:

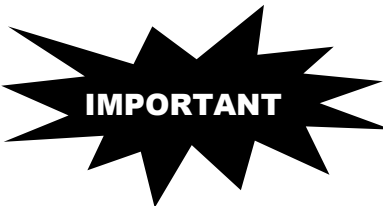

Product Notifications

We contact our customers in case of product updates.

Owner Verification

Registration can serve as verification of your ownership in the event of product theft or loss.

Efficient Service

Completing the warranty card will help you obtain more efficient warranty service in case there is a problem with your product.

Don't forget

Please take the time to register your product. Registration takes 2 minutes!

AMANO

Corporate Headquarters
140 Harrison Avenue, Roseland, NJ 07068-1239

Need Ribbons, Keys and Accessories?
Visit

WWW.TIMECLOCKEXPERTS.COM : 866-487-4751